



UNITED STATES COAST GUARD

INVESTIGATION INTO THE CIRCUMSTANCES
SURROUNDING THE SINKING OF THE
UNINSPECTED FISH PROCESSING VESSEL

ALASKA RANGER

OFFICIAL NUMBER 550138, IN THE BERING SEA ON
23 MARCH 2008 WITH THE LOSS OF FOUR LIVES AND
ONE PERSON MISSING AND PRESUMED DEAD



Page Intentionally Left Blank



16732

DEC 20 2010

**SINKING OF THE UNINSPECTED FISH PROCESSING VESSEL ALASKA RANGER,
OFFICIAL NUMBER 550138, IN THE BERING SEA ON 23 MARCH 2008 WITH THE
LOSS OF FOUR LIVES AND ONE PERSON MISSING AND PRESUMED DEAD**

ACTION BY THE COMMANDANT

The record and the report of the Formal Investigation convened to investigate the subject casualty have been reviewed. The record and the report, including the findings of fact, analysis, conclusions, and recommendations are approved subject to the following comments.

ACTION ON RECOMMENDATIONS

Recommendation 1: The USCG should broadly interpret and thoroughly apply all existing commercial fishing vessel regulations to best accomplish their purpose: safety. Waivers and exemptions should be minimized.

Action: I concur with this recommendation. Until the USCG is granted the authority to mandate inspection and certification of the commercial fishing vessel fleet, the existing regulations under 46 CFR Part 28 will be broadly interpreted to ensure the safety of crew and observers on board commercial fishing vessels. Exemptions will be considered only on a case-by-case basis for issues that will not directly impact safety.

Recommendation 2: The Commandant should review and revise the comprehensive commercial fishing vessel inspection plan proposed in 1992, and, again, request the additional legislative authority and resources necessary to implement an inspection program. This inspection program should include mandatory, regular inspections.

Action: I concur with this recommendation. I will direct the review of subject plan, taking into account the recent changes to the fishing vessel safety standards in 46 U.S.C. Chapter 45 enacted in the Coast Guard Authorization Act of 2010 (P.L. 111-281). These changes include a provision mandating dockside examinations of fishing vessels at least once every two years and the issuance of certificates of compliance to vessels that meet the required safety standards. In addition, I will recommend a review be conducted by the Commercial Fishing Safety Advisory Committee. Upon the completion of these reviews, any necessary revisions will be made to the plan with the intent of using it as a basis for a future legislative change proposal seeking additional authority for mandatory, periodic safety inspections of commercial fishing vessels.

Recommendation 3: The Commandant should ensure regulatory safety requirements for commercial fishing industry vessels are revised so they are commensurate with the route, number of people on board, complexity of operations, and other applicable risk factors.

Action: I concur with this recommendation. Consideration of amendments to the current regulatory safety requirements for commercial fishing industry vessels in 46 CFR Part 28 is underway as part of a current rulemaking project. While the applicability of existing requirements are already based on operation beyond boundary line, number of people on board, and keel lay date, amendments to the applicability criteria for the various safety requirements in those regulations will be considered, to the extent allowable under our statutory authority, as part of this rulemaking project. In addition, recent changes to 46 U.S.C. Chapter 45 enacted in the Coast Guard Authorization Act of 2010 (P.L. 111-281) extend the applicability of that chapter's safety requirements beyond only documented vessels and changed it from vessels operating beyond the boundary line to vessels operating beyond three nautical miles from the baseline from which the territorial sea of the United States is.

Recommendation 4: The Commandant should ensure the regulatory definition for "fish processing vessel" is revised to remove existing ambiguity and facilitate enforcement.

Action: I concur with the intent of this recommendation. The definition of "fish processing vessel" in 46 U.S.C. 2101(11b) does not need to be amended, however clarification and improvement is needed in identifying the actions taken by individual fishing vessels to commercially prepare fish or fish products in order to determine whether they meet the definition of a fish processing vessel. This can be done without amending the statutory definition. The USCG is now using information from commercial fishing vessels, as reported in the National Marine Fisheries Service (NMFS) Product and Delivery Codes published in Table 1 to 50 CFR 679, to determine the types of preparation activities being conducted on vessels and assess whether or not they meet the definition of a fish processing vessel.

Recommendation 5: The Commandant, NMFS, and the North Pacific Fishery Management Council should harmonize safety and conservation regulations. Safety and resource management decisions and requirements should complement each other. Fishing industry vessel owners should be encouraged to replace existing, older vessels with newer ones that meet the most stringent safety requirements.

Action: I concur with the intent of this recommendation. Safety and conservation regulations should be harmonized to the extent practical; however, the USCG lacks the authority to implement a solution on our own. Through our engagements with the National Marine Fisheries Service (NMFS) and the Fishery Management Councils, the USCG will work to this end. A copy of this report will be provided to NMFS and the each of the Fishery Management Councils with a proposal that an effort be undertaken to develop a strategy to harmonize safety and conservation regulations.

Recommendation 6: The ACSA program should be disestablished.

Action: I do not concur with this recommendation. While the initial implementation of the Alternate Compliance and Safety Agreement (ACSA) for Fish Processing Vessels program had some significant shortcomings, with appropriate changes, it is worth keeping. To address the identified shortcomings, the USCG revised the ACSA guidance and assigned three civilian inspector billets to Sector Seattle, the Thirteenth Coast Guard District, and Sector Anchorage to

provide the necessary oversight and management to ensure strict adherence to ACSA program requirements.

Recommendation 7: OCMI Seattle, OCMI Western Alaska, D13 and D17 should not issue or renew any exemptions, waivers, or equivalencies under ACSA.

Action: I do not concur with this recommendation. The significant shortcomings identified with the initial implementation of the ACSA program would justify restricting the issuance or renewal of exemptions under the program as it existed at the time of this marine casualty; however, revisions made to the program described in #6 above provide the necessary improvements to the program for the issuance of such exemptions while maintaining that the safety of the vessels

Recommendation 8: Assisted by experienced specialists from the Commandant's Office of Quality Assurance & Traveling Inspections (CG-54TI), OCMI Seattle, OCMI Western Alaska, D13 and D17 should examine and confirm the structural and material condition of all fish processing vessels currently operating with exemptions issued under ACSA.

Action: I concur with the intent of this recommendation. The USCG will have the structural and material condition of all fish processing vessels currently operating with exemptions issued under ACSA examined and confirmed to be in full compliance with ACSA requirements by our fishing vessel safety examiners and marine inspectors in our Thirteenth and Seventeenth Coast Guard Districts. Assistance will be provided from fishing vessel safety examiners and marine inspectors from other Districts and marine inspectors from our Headquarters Traveling Inspectors & Centers of Expertise staff, as appropriate.

Recommendation 9: Based on the results of the examinations discussed above, those vessels not likely to meet class and load line requirements should be immediately disenrolled from ACSA by the OCMI Seattle, OCMI Western Alaska, D13 or D17 and prohibited from operating as a fish processing vessel until they demonstrate compliance. Others should be given a sufficient amount of time necessary to obtain a load line and become classed, as necessary.

Action: I do not concur with this recommendation. The purpose of the ACSA Program was to give these vessels the opportunity to improve their structural integrity and material conditions to a level similar to that required under class and load line requirements because they could not meet those requirements. Further in some cases, the ACSA Program actually requires the vessels to meet criteria that exceed class/load line requirements or comply with safety requirements that are not even included in the class/load line requirements.

Recommendation 10: Unless the operator can demonstrate it was a fish processing vessel before 27 July 1990, the OCMI Seattle, OCMI Western Alaska, D13 and D17 should immediately require each existing fish processing vessel to comply with 46 CFR 28.720 and be classed by a qualified organization. Vessels unable to comply should be prohibited from operating as a fish processing vessel.

Action: I partially concur with this recommendation. The requirements under 46 CFR 28.720 only apply to vessels built after, or which undergo a major conversions completed after, 27 July

1990. Vessels that have been built after or which undergo a major conversion after 27 July 1990 should comply with the survey and classification requirements of 46 CFR 28.720; however, there are other vessels that are not built after, or have not undergone a major conversion after 27 July 1990, that were previously not considered fish processing vessels, but are now due to our use of the National Marine Fisheries Service by-catch requirements and product codes.

Recommendation 11: Unless it is less than 5000 GT and the operator can demonstrate it was constructed as a fish processing vessel before August 16, 1974 or converted to a fish processor before January 1, 1983, the OCMI Seattle, OCMI Western Alaska, D13 and D17 should immediately require each existing fish processing vessel to comply with 46 CFR Subchapter E and obtain a load line. Vessels unable to comply should be prohibited from operating as fish processing vessels.

Action: I do not concur with this recommendation. The purpose of the ACSA Program was to give these vessels the opportunity to improve their structural integrity and material conditions to a level similar to that required under class and load line requirements because they could not meet those requirements. Further in some cases, the ACSA Program actually requires the vessels to meet criteria that exceed class/load line requirements or comply with safety requirements that are not even included in the class/load line requirements.

Recommendation 12: If the ACSA program is continued, Commandant, D13, and D17 must reevaluate ACSA standards and procedures and ensure they provide a level of safety equivalent to that provided by the applicable regulations. In addition, there must be adequate oversight to ensure the standards are properly enforced and compliance is achieved. For example, the vessel stability requirements in ACSA must provide clear standards to participating naval architects. In addition, the stability analyses produced by naval architects for vessel operators should be reviewed by the USCG MSC or a qualified third party.

Action: I concur with this recommendation. To address the identified shortcomings of the initial implementation, the ACSA program was reviewed, revisions were made to the ACSA guidance, and the USCG established three civilian inspector billets assigned to Sector Seattle, the Thirteenth Coast Guard District, and Sector Anchorage specifically to provide the necessary oversight and management to ensure strict adherence to ACSA program requirements. The program will be amended further to require that stability analyses produced by naval architects for vessels operators under ACSA be reviewed by our Marine Safety Center.

Recommendation 13: The Commandant should clearly state that a change of service from a "fishing vessel" to a "fish processing vessel" is a major conversion per 46 USC 2101(14a). Any commercial fishing industry vessel that changes service and begins operating as a fish processing vessel after 27 July 1990 should be required to meet the survey and classification requirements in 46 CFR 28.720.

Action: I partially concur with this recommendation. A conversion of a vessel that changes its service from a fishing vessel to a fish processing vessel meets the definition of a major conversion as it results in a change in the type of vessel. Vessels that undergo this conversion after 27 July 1990 are required to meet the survey and classification requirements in 46 CFR

28.720, unless they are granted an exemption under 46 CFR 28.60. For those vessels that are determined on a case by case basis to qualify, they may be enrolled in the Alternate Compliance and Safety Agreement (ACSA) Program and receive such an exemption.

Recommendation 14: The Commandant should clarify and enforce the regulatory requirements regarding the use of licensed engineering personnel on commercial fishing vessels and fish processing vessels that elect to provide an engineering watch.

Action: I concur with this recommendation. Updated guidance and training to clarify the regulatory requirements regarding the use of licensed engineering personnel on commercial fishing vessels and fish processing vessels who elect to provide an engineering watch will be developed and provided to marine inspectors, fishing vessel safety examiners, and law enforcement boarding officers.

Recommendation 15: The Commandant should initiate regulatory changes to prohibit the use of alcohol aboard commercial fishing industry vessels. This is consistent with the 1987 National Transportation Safety Board study, "Uninspected Commercial Fishing Vessel Safety," which recommended an absolute prohibition against the use of alcohol and/or drugs while engaged in commercial fishing operations.

Action: I concur with the intent of this recommendation. In accordance with 33 CFR 95.045, the use of alcohol by crew members is prohibited on board all commercial fishing industry vessels subject to inspection under 46 USC Chapter 33. However, as documented in our response to the NTSB safety recommendation, the USCG does not have the statutory authority to prohibit the use of alcohol aboard uninspected commercial fishing industry vessels. Our authority for uninspected vessels is limited to prohibiting the operation of vessels while under the influence of alcohol, or dangerous drugs, as implemented in 33 CFR Part 95. Those regulations do specifically state that the marine employer for a vessel may limit or prohibit the use or possession of alcohol on board a vessel above and beyond the requirements of those regulations, a practice we specifically encouraged in the notice of proposed rulemaking in May 1986, and which we still encourage marine employers to implement today.

Recommendation 16: The Commandant should develop and publish standards for the proper placement of bilge high level alarm actuators to provide the earliest warnings of abnormal bilge accumulation for all vessels, and establish inspection and verification procedures for inspected vessels to ensure they are properly installed. Current inspection procedures ensure bilge high level alarms are operable, but, without a standard for placement of the actuator, there is no inspection requirement or practice to verify the height of the alarm actuator above the bilge.

Action: I partially concur with this recommendation. The placement of bilge high level alarm actuators should be such that they provide early warning of abnormal bilge accumulation and guidance will be provided to our examiners to check that the installations are such that they meet that requirement; however, the USCG should not develop new, prescriptive standards for their placement. The development of prescriptive standards for the placement of bilge high level alarm actuators is not feasible given the wide variance of vessel bilge arrangements. Instead, the

DEC 20 2010

USCG will advise our examiners to refer to existing performance based rules on bilge alarm placement, such as classification society rules.

Recommendation 17: The Commandant should include standards for the placement of bilge high level alarm actuators and inspection and verification procedures for high bilge alarm actuators in the proposed amendments to the commercial fishing industry vessel regulations (Docket No. USCG–2003–16158).

Action: I concur with the intent of this recommendation. The development of prescriptive standards for the placement of bilge high level alarm actuators is not feasible given the wide variance of vessel bilge arrangements; however, proper placement and periodic testing of bilge high level alarm, their inspection and verification will be considered in the course of the ongoing regulatory project on commercial fishing industry vessel safety.

Recommendation 18: As part of the proposed amendments to its commercial fishing industry vessel regulations (Docket No. USCG–2003–16158), the Commandant should consider increasing the frequency of inspections for personal lifesaving equipment, such as survival suit lights, to ensure this equipment is ready when needed.

Action: I concur with this recommendation. The issue of inspection frequency and documentation for personal lifesaving equipment, such as survival lights, will be considered in the course of the ongoing regulatory project on commercial fishing industry vessel safety.

Recommendation 19: As part of the proposed amendments to its commercial fishing industry vessel regulations (Docket No. USCG–2003–16158), the Commandant should consider requiring vessel owners to ensure each person onboard has a survival suit that reasonably fits body frame.

Action: I concur with this recommendation. Owner and master responsibilities for ensuring that each person onboard has a survival suit that reasonably fits their body frame will be considered in the course of the current regulatory project on commercial fishing industry vessel safety.

Recommendation 20: As part of the proposed amendments to its commercial fishing industry vessel regulations (Docket No. USCG–2003–16158), the Commandant should require masters to conduct abandon ship drills that incorporate distribution of survival suits to all persons onboard to ensure that each person receives a survival suit that reasonably fits the individual's body frame.

Action: I concur with this recommendation. Requirements for masters to conduct abandon ship drills that incorporate distribution of survival suits to all persons onboard will be considered in the course of the current regulatory project regarding commercial fishing industry vessel safety.

Recommendation 21: The Commandant should examine the training and proficiency requirements for Rescue Swimmers and ensure they adequately address recovery of a non-responsive or combative survivor. Regular training with life-like mannequins should be considered.

Action: I concur with this recommendation. The Rescue Swimmer training program already involves extensive training using scenarios with life-like mannequins and real-life swimmers which are non-compliant and non-responsive. This report will be forwarded to our Force Readiness Command (FORCECOM) for analysis to identify and implement any improvements in Rescue Swimmer training related to this topic.

Recommendation 22: The Commandant should review the storage location of the shroud cutter in its HH-65 helicopters and consider moving them within arm's reach of a flight mechanic working at the doorway.

Action: I concur with this recommendation. An Aircraft Configuration Control Board (ACCB) will be initiated to study this issue and identify the best place for rescue devices, including the shroud cutter and knife, on the HH-65 helicopters.

Recommendation 23: The Commandant should review the standard operating procedures for Mass Rescue Operations to ensure communications are efficient and effective and the accountability of all personnel, missing and recovered, is ensured.

Action: I concur with this recommendation. Passenger accountability is a central focus of our Coast Guard Mass Rescue Program, as well as that of most of our worldwide search and rescue (SAR) partners. The issue was highlighted during both our Caribbean 2007 and Alaska 2009 Mass Rescue Full Scale Exercises and resulted in two long term Remedial Action items: #3322 – Standardized Accountability Process, and #3318 – Accountability of Crew and Passengers which continue to be tracked in our Contingency Preparedness System. The USCG continues to establish guidelines and/or procedures in the current plans to coordinate rescued passengers and crew (accountability) when they are brought ashore. A six (6) step accountability process is currently being validated, which will be a main exercise objective in the Boston 2011 Mass Rescue Full Scale Exercise. Once validated, that process will be staffed for inclusion in the International Maritime Organization's Maritime Safety Committee Circular (MSC/Circ. 1079), "Guidelines for Preparing Plans for Co-Operations between Search and Rescue Services and Passenger Ships" and incorporated in our Mass Rescue Operation guidelines, policies and procedures.

Recommendation 24: USCG CVFS Examiners should educate the masters, officers and crew on the importance of correctly fitting survival suits and emphasize that individuals have ready access to a survival suit that fits reasonably.

Action: I concur with this recommendation. USCG commercial fishing vessel safety examiners, while conducting dockside safety examinations, which include checks of survival suits, will ensure that masters, officers, and crew members of fishing vessels are aware of the importance of correctly fitting survival suits and the need for individuals to have ready access to those suits. In addition, a lessons learned will be published highlighting this issue for those who have not submitted to a dockside safety examination.

DEC 20 2010

Recommendation 25: FCA should consult with a competent naval architect or structural engineer and ensure existing Kort nozzles on other FCA vessels are properly installed and maintained.

Action: I concur with this recommendation. FCA will be provided with a copy of this report and this recommendation for their consideration and action, as appropriate.

Recommendation 26: FCA should consult with a competent naval architect or structural engineer and ensure that other vessels with outer transoms are properly gauged and internally examined to ensure the material condition of each is properly maintained.

Action: I concur with this recommendation. FCA will be provided with a copy of this report and this recommendation for their consideration and action, as appropriate.

Recommendation 27: FCA and other vessel owners should have written safety training instructions to ensure training and drills include all elements of the regulations and are completed as required. Written procedures minimize human error and human omission that may occur when procedures are informal and shore side personnel assume vessel personnel know and understand all aspects of the owner's policy and applicable safety regulations.

Action: I concur with this recommendation. FCA will be provided with a copy of this report and this recommendation for their consideration and action, as appropriate. In addition, a list of lessons learned will be published on this topic to raise the awareness of other fishing vessel owners and operators

Recommendation 28: FCA and other vessel owners should have written emergency procedures to ensure personnel onboard understand proper procedures to follow in an emergency. Written emergency procedures document the owner's procedures and ensure that activities on board affecting safety are planned, organized, and executed in accordance with the owner's requirements and applicable safety regulations.

Action: I concur with this recommendation. FCA will be provided with a copy of this report and this recommendation for their consideration and action, as appropriate. In addition, a list of lessons learned will be published on this topic to raise the awareness of other fishing vessel owners and operators

Recommendation 29: Owners and operators of vessels with controllable pitch propellers should understand how their installed system will respond to a loss of power and other likely modes of failure, develop and implement sufficient emergency procedures, and ensure officers and crews are trained to take appropriate measures.

Action: I concur with this recommendation. A lessons learned on this issue will be published to raise awareness of fishing vessel owners and operators so they can address this issue.

DEC 20 2010

Recommendation 30: USCG Safety Alert 03-08 should be widely distributed to vessel owners and operators. CFVS Examiners should provide a copy of the Safety Alert to each vessel they examine that uses controllable pitch propellers.

Action: I concur with this recommendation. Safety Alert 03-08, “*Controllable Pitch Propeller Systems and Situational Awareness*,” has been distributed to the maritime community and posted it on various Coast Guard Internet sites. In addition, examiners will have copies of the alert and to distribute to fishing vessel owners and operators.

Recommendation 31: Owners and operators of fishing vessels should pay particular attention to fishing industry vessels that have outer transoms, and ensure the entire vessel is properly inspected and maintained, not just readily accessible spaces.

Action: I concur with this recommendation. Our commercial fishing vessel safety examiners will be made aware of this issue and discuss it with vessel owners and operators when conducting dockside visits or examinations. In addition, a list of lessons learned will be published to raise awareness of this issue among all fishing vessel owners and operators.

Recommendation 32: NMFS should be commended for ensuring fisheries observers are provided with personal EPIRBs and properly sized survival suits.

Action: I concur with this recommendation. I commend the National Marine Fisheries Service (NMFS) for their support of maritime safety by ensuring fishery observers are provided with personal EPIRBs and properly sized survival suits. An opportunity for more formal recognition will be explored.

Recommendation 33: To further enhance the safety of fisheries observers, NMFS should require observers to confirm the vessel's officers are properly licensed each time they conduct a pre-trip safety check under 50 CFR Part 600.

Action: I concur with this recommendation. A copy of this report will be forwarded to the National Marine Fisheries Service for their consideration and action on this recommendation, as appropriate.

Recommendation 34: The OCMI Western Alaska should initiate an investigation into possible violation of the serious marine incident chemical testing requirements in 46 CFR 16.240.

Action: I concur with this recommendation. This situation will be referred to the Officer in Charge, Marine Inspection, for investigation into the possible violations identified in this report.

Recommendation 35: The OCMI Western Alaska should initiate an investigation into possible violation of the vessel manning requirement in 46 USC 8304 and 46 CFR 15.825 regarding the improperly and unlicensed engineers.

Action: I concur with this recommendation. This situation will be referred to the Officer in Charge, Marine Inspection, for investigation into the possible violations identified in this report.

DEC 20 2010

Recommendation 36: The OCMI Western Alaska should initiate an investigation into possible violation of the vessel manning requirement in 46 USC 8103(a) and 46 USC 8304 regarding the vessel being improperly under the control of an unlicensed non-U.S. citizen.

Action: I concur with this recommendation. This situation will be referred to the Officer in Charge, Marine Inspection, for investigation into the possible violations identified in this report.

Recommendation 37: Recommend this investigation be closed.

Action: This investigation is closed



THOMAS F. ATKIN
Rear Admiral, U.S. Coast Guard
Assistant Commandant for Marine Safety, Security and Stewardship

Executive Summary

On 22 March 2008, at approximately 1210 Alaskan Daylight Savings time, the ALASKA RANGER got underway from Dutch Harbor, AK. The 190 foot long trawler operated as a fish processing vessel and was en route to Petrel Bank, approximately 500 miles due west from Dutch Harbor, to fish for mackerel. There were 47 people onboard consisting of two deck officers, three engineers, five Japanese nationals that served as foreign fisheries specialists, two National Marine Fisheries Service (NMFS) observers, and 35 factory workers/deckhands.

Around 0226 on 23 March, with the ship approximately 130 miles west of Dutch Harbor, the rudder room's high bilge water alarm sounded. The engineer on watch went aft to investigate, found the rudder room flooding rapidly, dogged the rudder room watertight door closed, started the bilge pump, and alerted the pilot house that the vessel had "major flooding." A few moments later, the general alarm was sounded. Attempts by the crew to control the flooding quickly ceased and adjacent spaces, including the engine room, experienced progressive flooding. The crew mustered in the pilot house and donned their survival suits.

At approximately 0402 the vessel suddenly rolled to starboard, and the crew began to abandon ship. The vessel was backing, or going astern, when the liferafts were deployed. As a result, the liferafts were dragged from the bow and could not be pulled alongside and positioned at the designated embarkation stations. By approximately 0420 the vessel was listing approximately 45° to starboard, and crew members were forced to jump into the 32°F water. Shortly after 0430, the ALASKA RANGER stood straight up on its stern with only its bow sticking out of the water and sank.

The ALASKA WARRIOR, also en route from Dutch Harbor to Petrel Bank, learned of the difficulties encountered by the ALASKA RANGER at 0242 and headed toward them at best possible speed. The USCG received a Mayday call from the Mate on the ALASKA RANGER at 0248, and the CGC MUNRO, approximately 127 nautical miles to the north, diverted to go render assistance. Between approximately 0505 and 1010, the CGC MUNRO, two USCG helicopters, and the ALASKA WARRIOR rescued 42 people and recovered four bodies.

Of the 47 people aboard the ALASKA RANGER, 22 managed to board one of the vessel's liferafts soon after abandoning ship and each of them survived. Of the 25 people who did not get into one of the vessel's liferafts, 20 were rescued, four died, and one remains missing and is presumed dead. The deceased include the Captain, Mate, Chief Engineer, Fish Master, and one Factory Worker.

Throughout the emergency and rescue efforts, many people aboard the ALASKA RANGER awakened shipmates, helped others don immersion suits, provided encouragement, and assisted each other with entry into liferafts and survival in the water. The exceptional performance of the officers and crew of the ALASKA WARRIOR, the first ship to arrive on scene, the USCG helicopter crews, and CGC MUNRO personnel was vital to the rescue of the 42 survivors.

The cause of the casualty was a breach in the watertight envelope of the hull and progressive flooding in the engine room and other spaces at the stern of the vessel. The exact initiating event

that created the source of flooding is unknown. However, it was likely related to the vessel's poor material condition and may have possibly been related to the Kort nozzle struts, which were believed to have created excessive local stresses where they attached to a corroded area of the hull.

Bottom Line Up Front

The underlying conditions that led to the loss of the ALASKA RANGER were not unique to this vessel. Nor were they new. Significant changes are necessary to prevent more casualties.

Without sufficient enforcement of existing requirements, better statutory definitions, more comprehensive safety regulations, and periodic inspections, safety for the men and women working aboard fishing industry vessels will continue to be jeopardized. Changes must be pursued immediately before additional lives are lost and another chapter is added to the “tragedy of missed opportunities.”¹

Current standards for fish processing vessels and other commercial industry fishing vessels are not commensurate with risk. No new studies are needed.

For decades, various studies, reports, and casualty investigations conducted by the USCG, National Transportation Safety Board, industry groups, and other experts have repeatedly documented the shortcomings of the laws, regulations, and policies intended to provide for the safety of fish processing vessels, other commercial fishing industry vessels, and the many crew members who work aboard them.

In spite of many attempts to provide clarity by supplying additional interpretations, the absence of a concrete and universal “fish processing vessel” definition makes application and enforcement of the existing regulations problematic.

In a memo dated 19 July 1990 to the Chairman of the Senate Committee on Commerce, Science, and Transportation, the Commandant stated “Questions concerning the definition of what is or is not a fish processing vessel complicates the enforcement issue.” This remains true today.

Changes implemented to improve safety have focused on voluntary measures in lieu of mandatory inspections. To prevent further losses, the USCG must immediately enforce all existing regulations and statutes to the maximum extent possible and begin exercising all of its authority to compel compliance.

With the exception of a brief period in the late 1980s and early 1990s, the USCG has adopted a passive approach toward enforcement of commercial fishing vessel regulations. When the USCG took a firm stance and strictly enforced class and load line requirements, fish processing

¹ Hiscock, R.C., “Fishing Vessel Safety in the United States, The Tragedy of Missed Opportunities,” IFISH, October 2000

vessels not in compliance were not permitted to fish and were fined for failure to satisfy class and load line requirements. In reply to a controversial appeal involving a fish processing vessel operator who objected to the USCG's application of load line requirements to his vessel, the Commandant emphatically stated "the marine safety laws are intended to be interpreted broadly to best accomplish their purpose, safety (i.e., exemptions should be narrowly construed)." Yet today, broad class and load line exemptions, with little or no justification, are being granted under the Alternate Compliance and Safety Agreement to vessels whose material condition is suspect.

The USCG must review and revise the comprehensive commercial fishing vessel inspection plan proposed in 1992, as necessary, and again request the additional legislative authority and resources necessary to implement an inspection program.

In 1992, the Commandant sent a proposal to Congress that outlined a comprehensive plan to require mandatory inspection of commercial fishing industry vessels. Though it was expected to "generate moderate controversy," the USCG stated it was necessary because previous efforts to improve safety in the fishing industry "had been hampered by the lack of legislative authority, coupled with the lack of support and objections by the industry itself." The USCG's plan was supported by two independent studies and requested the necessary legislative changes and authority, but Congress never acted on it.

Page Intentionally Left Blank

CONTENTS

Executive Summary	i
Bottom Line Up Front	ii
List of Figures	1
List of Abbreviations	3
Vessel Particulars	5
Vessel Description	6
Construction	6
Conversion	7
Arrangements	9
Engineering	14
Subsequent Hull Modifications	15
Vessel Personnel	15
Officers	15
Foreign Fisheries Specialists	16
Factory Workers/Deck Hands/Stewards	17
National Marine Fisheries (NMFS) Observers	17
Factory Operations	18
Weather	18
The Casualty	19
Background	19
The Alarm	20
Damage Control	21
Crew Muster	23
Abandon Ship	24
Search and Rescue	25
Owners and Operators	30
Owner	30
Operator	30
Third Party Examinations	31
Prior to 2006	31
Recent Examinations	34

Hull Condition and Structural Repairs	43
Aft Ballast Tanks	43
Ramp and Stern	44
Storerooms	46
Potable Water Tanks	47
Other areas	48
Kort Nozzles	49
Installation	49
Repairs	54
Management of Vessel Repairs and Maintenance	56
Role of Trans Marine Propulsion Services (TMPS)	56
Performance of TMPS and Fishing Company of Alaska	57
Controllable Pitch Propeller System	58
Design	58
Remote Main Engine Emergency Shutdowns	59
Rudder	60
Installation	60
Possible Loss of Rudder	62
Vessel Stability	63
Stability Standards	63
Stability Tests	64
Stability Test Analysis	65
Vessel Stability	65
Vessel Stability Analysis	65
Stability Guidance	66
Pre-casualty Stability	67
Review of Key Events in the Flooding and Sinking	68
Technical Analysis of Likely Flooding Scenarios	69
Flooding Rate Assessment	70
Drugs & Alcohol Regulations and Policy	71
Standards and FCA Policy	71
Alcohol Use	71
Post Casualty Testing	72

Vessel Manning and Operations	72
Manning	72
Operations in Ice	73
Role of the Fish Master	74
Safety Training and Equipment	75
Instruction, Drills, and Training	75
FCA’S Role in Instruction, Drills, and Training	76
Vessel Emergency Squad	77
Emergency Communications Equipment	77
Liferafts	77
Survival Suits	78
Bilges and High Level Alarms	80
Safety Culture	81
Compliance with the Trim & Stability Booklet	81
Watertight Doors	81
Alcohol Use and Substandard Watchkeeping	82
Crew Performance	82
Damage Control	82
Abandon Ship	83
Search and Rescue Operations	84
USCG Hoisting Procedures	84
Proficiency Requirements	85
Experience	86
The Loss of Crew Member A	86
The Count	89
“Fish Processing Vessel” – Unclear Definitions & Enforcement Challenges	90
Replacement Vessels	93
ACSA Program	94
Background	94
Clarification of the Definition of Fish Processing Vessel	96
ACSA Policy Documents	96
Premise Behind the Program	97
Exemption Justification	98
ACSA Application Timeline	99
ACSA Enrollment Process and the ALASKA RANGER	100

ACSA Inspection Requirements and the ALASKA RANGER	104
Stability and Watertight Integrity	105
Drydock Examination	107
Hull Plating Thickness Gaugings	109
Lifesaving	111
Emergency Preparedness, Communications and Navigation	112
Fire Safety	113
Machinery	115
USCG Performance	116
Conclusions	121
Recommendations	129
Appendix A: Crew List/Position/Training	A-1
Appendix B: Weather Information	B-1
Appendix C: Glossary	C-1
Appendix D: MSC Analysis	D-1
Appendix E: Safety Alert 01-08 Regarding Watertight Integrity	E-1
Appendix F: Safety Alert 03-08 Regarding CPP Systems and Situational Awareness	F-1
Appendix G: Summary of Activities by the Marine Board of Investigation	G-1
Appendix H – Convening Order	H-1

List of Figures

Figure 1: Undated photograph of ALASKA RANGER, starboard side.....	6
Figure 2: Undated photograph of ALASKA RANGER, port side	7
Figure 3: Inboard Profile of the ALASKA RANGER.....	8
Figure 4: Hold Deck.....	9
Figure 5: Double Bottom	10
Figure 6: Main Deck.....	11
Figure 7: Shelter Deck.....	12
Figure 8: Foc'sle Deck	13
Figure 9: Pilot House Deck.....	14
Figure 10: Vessel Trackline for 17 to 23 March (Provided by NMFS and based on VMS data). 19	
Figure 11: Reported position of the ALASKA RANGER at the time of the casualty.	20
Figure 12: Relative distance of USCG response assets	26
Figure 13: Summary of Third Party Examinations.....	32
Figure 14: Excerpt from “Yearend Vessel Plan Items for Alternative Compliance Program”	36
Figure 15: Work done to the Aft Ballast Tanks.....	44
Figure 16: Work done to the stern and ramp	45
Figure 17: Photograph of the stern taken in 2005 showing water draining from outer transom ..	45
Figure 18: Photograph of the outer transom.	46
Figure 19: Work done to the store rooms.	46
Figure 20: Work done to potable water tanks.....	47
Figure 21: Photograph taken inside of potable water tank showing doubler.....	48
Figure 22: List of repairs made in other spaces and portions of the hull.....	49
Figure 23: Portion of nozzle manufacturer’s installation drawing	51
Figure 24: Portion of drawing developed by shipyard for Kort nozzle installation	52
Figure 25: Upper right red circle: Location of Kort nozzle strut fractures.....	53
Figure 26: List of repairs made to the Kort nozzles.....	54
Figure 27: Excerpt from page 29 of Enclosure 1 to NVIC 7-68.....	55
Figure 28: Photograph of worker repairing the inboard port Kort nozzle strut.....	55
Figure 29: Rudder configuration.....	60
Figure 30: Steel Tiller Assembly showing hydraulic steering system connection.....	62
Figure 31: Photograph of ice encountered by the ALASKA RANGER in February 2008.....	74
Figure 32: Photograph of rescued ALASKA RANGER crew member in survival suit.....	79
Figure 33: Photograph of LTJG ██████████ demonstrating position of Crew Member A	88
Figure 34: Summary of ACSA Enrollment Deadlines	101
Figure 35: ALASKA RANGER Catch Sorted by ACSA Product Code	102
Figure 36: Excerpt from ACSA enrollment application for the ALASKA RANGER.....	103
Figure 37: ALASKA RANGER's remaining ACSA worklist items, as reported by FCA.....	104

Page Intentionally Left Blank

List of Abbreviations

ABS	American Bureau of Shipping
ACSA	Alternate Compliance and Safety Agreement
ADT	Alaska Daylight Savings Time
AIRSTA	United States Coast Guard Air Station
AIS	Automatic Information System
ASTM	American Society for Testing and Materials
CC	Command Center
CDOA	Commandant Decision on Appeal
CFVS	Commercial Fishing Vessel Safety
CFR	Code of Federal Regulations
CGC	United States Coast Guard Cutter
CGHQ	United States Coast Guard Headquarters
CID	Chief, Inspections Department
COC	Certificate of Compliance
COD	Certificate of Documentation
COMSTA	United States Coast Guard Communication Station
CPP	Controllable Pitch Propeller
D13	Thirteenth Coast Guard District
D17	Seventeenth Coast Guard District
DECAL	United States Coast Guard CFVS Exam Decal
DNV	Det Norske Veritas
EBDG	Elliot Bay Design Group
EPIRB	Emergency Position Indicating Radio Beacon
FCA	Fishing Company of Alaska
FEACT	United States Coast Guard Activities Far East
FPV	Fish Processing Vessel
F/V	Fishing Vessel
FR	Federal Register
GMDSS	Global Maritime Distress and Safety System
GPM	Gallons per minute
GRT	Gross Registered Tons, measured under U.S. Regulatory Measurement System
H&G	Head and Gut
HACCP	Hazard Analysis and Critical Control Point
HF	High Frequency
HH-60	United States Coast Guard Helicopter CG 6007
HH-65	United States Coast Guard Helicopter CG 6566
HP	Horsepower

ICLL	International Convention on Load Lines
INMARSAT	International Maritime Satellite Organization
ISE	Internal Structural Examination
ITC	International Tonnage Convention
kW	Kilowatt
LOA	Length Overall
LT	Long Ton
LTJG	Lieutenant Junior Grade
MBI	Marine Board of Investigation
MI	United States Coast Guard Marine Inspector
MISLE	Marine Information for Safety and Law Enforcement System
MSC	United States Coast Guard Marine Safety Center
MSD	United States Coast Guard Marine Safety Detachment
MSO	United States Coast Guard Marine Safety Office
NFPA	National Fire Protection Association
NM	Nautical Miles
NMFS	National Marine Fisheries Service
NOAA	National Oceanographic and Atmospheric Administration
NPSC	North Pacific Search and Rescue Coordinator
NTSB	National Transportation Safety Board
NVIC	Navigation and Vessel Inspection Circular
OCMI	Officer in Charge, Marine Inspection
SAR	Search and Rescue
SOLAS	International Convention for the Safety of Life at Sea
STCW	Standards for Training Certification and Watchkeeping
TMPS	Trans Marine Propulsion Systems
UL	Underwriters Laboratories
UMIB	Urgent Marine Information Broadcast
USC	United States Code
USCG	United States Coast Guard
UTC	Universal Time Coordinated
V	Volt
VHF	Very High Frequency
WTD	Water Tight Door

Vessel Particulars

Name:	ALASKA RANGER (Ex RANGER)
Official Number:	550138
Service:	Fish Processing Vessel
Document Endorsement:	Coastwise, Fishery, Registry
Regulatory Gross/Net Tonnage	298 GRT /203 NRT
ITC Gross/Net Tonnage	1577 GT ITC/632 NT ITC
Registered Length:	189.4 feet
Registered Breadth:	40.0 feet
Registered Depth:	28.0 feet
Length Overall:	206.5 feet
Constructed:	Amelia, LA
Shipyard:	McDermott Shipyard, Inc
Year:	1973
Hull Material:	Steel
Converted to Fishing Vessel:	Seattle, WA
Shipyard:	United Marine Shipbuilding
Year:	1989
Propulsion:	2 Nohab Polar 16 cylinder diesel engines driving Bird-Johnson CPP
Horsepower:	3520 HP each engine
Insured Value:	\$4,000,000
Homeport:	Seattle, WA
Inclining Test Conducted:	10 June 2005
Date of Recent Stability & Trim Booklet:	11 January 2006
Last Drydock:	Circa November 2007, Ishinomaki, Japan
Load Line Certificate:	Expired since 1998
CFVSE Decal:	Invalid. Vessel was enrolled in ACSA and required to have a valid COC
Owner:	FCA Holdings, Inc
Managing Owner:	FCA Holdings, Inc

Vessel Description



Figure 1: Undated photograph of ALASKA RANGER, starboard side

Construction

The RANGER was originally constructed as an offshore supply vessel in 1973 at McDermott Shipyard in Morgan City, LA. It was an all welded vessel, longitudinally framed in the deck and bottom, transversely framed in the sides, and fitted with four transverse watertight bulkheads. Ordinary strength steel was used and the shell plating was ½ inch thick and the deck plating was 5/16 and 1/2 inch thick. The hull scantlings, rudder, rudder stock, steering gear, and propeller were not strengthened or approved by ABS for operation in ice.

Built under survey by the American Bureau of Shipping (ABS), the vessel was classed $\#A1$ Towing Service and $\#AMS$ indicating it complied with the hull and machinery requirements of the ABS Rules for unrestricted ocean service. It operated as an offshore supply vessel for approximately 13 years, and its Certificate of Inspection was deactivated in 1987.



Figure 2: Undated photograph of ALASKA RANGER, port side

Conversion

The RANGER was purchased by FCA Holdings, Inc, in 1988, converted to a commercial fishing industry vessel at United Marine Shipbuilding in Seattle, WA, in 1989, and renamed the ALASKA RANGER. After its conversion to a dry-hold stern trawler, ABS classification was surrendered. The ALASKA RANGER operated as a “Head & Gut” fishing industry vessel primarily in the Gulf of Alaska and the Bering Sea with a crew of approximately 49 people.

The design and arrangement of the ALASKA RANGER was typical of an offshore supply vessel converted to a fish trawler/processor. An all steel vessel with three complete decks, pilot house and raised foc’sle, the ALASKA RANGER had a raked stem, straight sides and a transom stern. The decks had pronounced sheer forward and the deck house was located forward of amidships with hatches from the open trawl deck to the fish bin and aft holds.

During the 1989 conversion, the vessel was razed to the main deck and reconstructed from that point upwards. The full length of the main deck was enclosed providing space for the factory, or processing space. Below the main deck the double bottoms were reportedly raised to 4 feet above the baseline, and the former mud tanks were replaced with fish holds. In addition, the exhaust stacks, originally located forward, were moved aft directly over the engine room. The vessel was outfitted with two gantries for fishing operations; one was amidships, and the other was over the stern ramp.

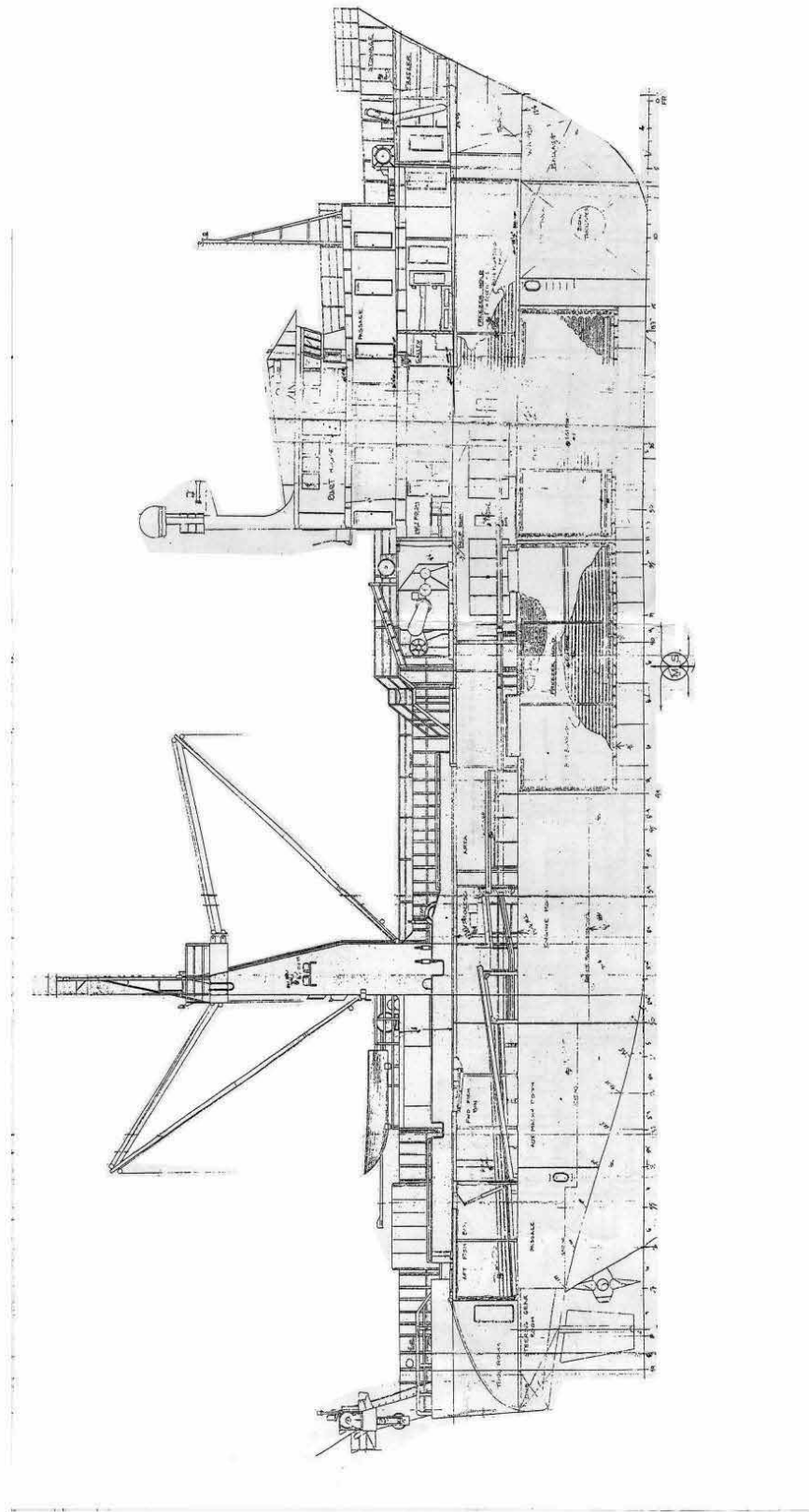
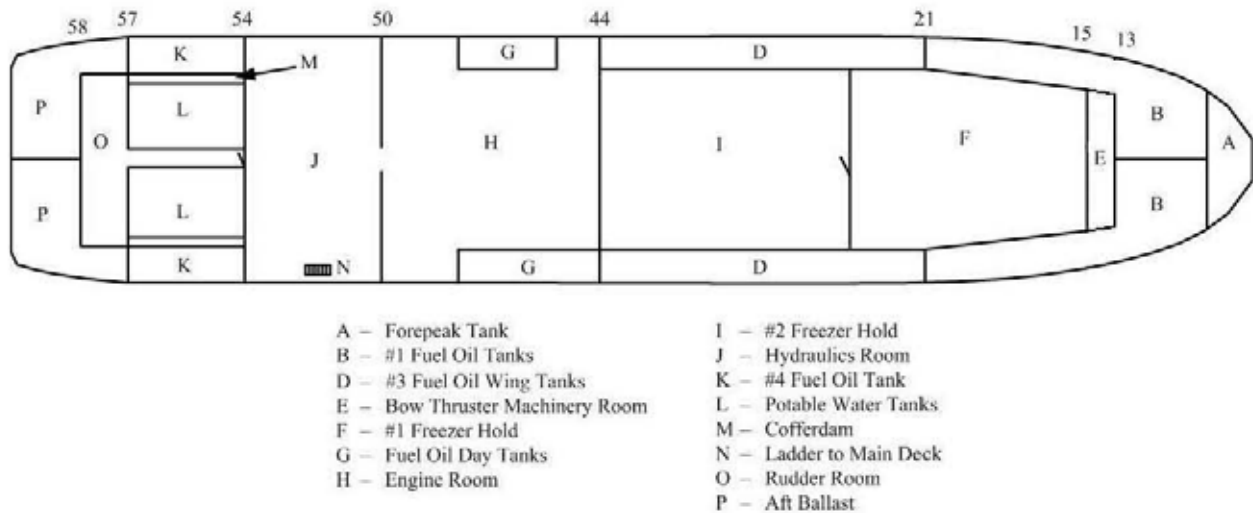

Figure 3: Inboard Profile of the ALASKA RANGER

Arrangements



Note: Figure is not to scale.

Figure 4: Hold Deck

The lower most deck was the hold deck, consisting primarily of engineering and refrigerated spaces. At the bow was the forepeak tank; moving aft were the #1 port and starboard fuel oil tanks outboard of the centerline bow thruster room. Continuing aft were the #1 and #2 freezer holds. Outboard of these two freezer holds were the #1 and #3 port and starboard wing fuel oil tanks. Aft of the freezer holds was the engine room. Outboard of the engine room were the port and starboard fuel oil day tanks and the port and starboard oil tanks.

The hydraulics room was aft of the engine room, between frames 50 and 54. Between the engine room and hydraulics room was a non-watertight bulkhead without any closures and containing penetrations for the propulsion shafting. Under the hydraulics room, and extending aft to frame 57, were the #4 port and starboard double bottom/wing fuel oil tanks.

A watertight door in the aft bulkhead of the hydraulics room opened into a longitudinal passageway that led to the rudder room. Outboard of this passageway were port and starboard potable water tanks, narrow port and starboard cofferdams, and along the skin of the ship the #4 fuel oil tanks. At the end of the passageway, the rudder room ran transversely and contained the rudder posts and associated steering gear. Wrapping around the aft and sides of the rudder room were port and starboard aft ballast tanks. These tanks were extended aft approximately 86 inches during the conversion.

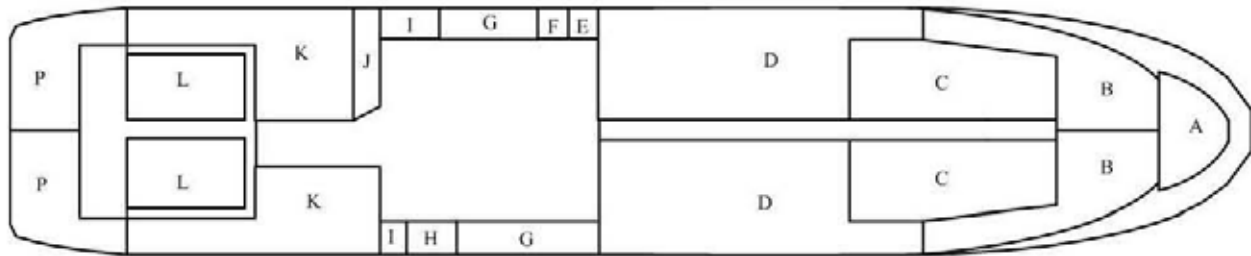

- | | |
|------------------------|-------------------------|
| A - Forward Ballast | H - Dirty oil Tank |
| B - #1 Fuel Oil Tanks | I - Lube Oil Tanks |
| C - #2 Fuel Oil Tanks | J - Hydraulic Oil Tank |
| D - #3 Fuel Oil Tanks | K - #4 Fuel Oil Tanks |
| E - Oily Water Tank | L - Potable Water Tanks |
| F - Waste Oil Tank | P - Aft Ballast |
| G - Fuel Oil Day Tanks | |

Note: Figure is not to scale.

Figure 5: Double Bottom

Below the Hold Deck were a variety of tanks and spaces, some extending to the Hold Deck (e.g. double bottom fuel tanks below the freezer holds, engine room bilges) and others extending to the Main Deck. At the bow was the forepeak tank; moving aft were the #1, #2 and #3 port and starboard fuel oil tanks. The #1 and #3 tanks were double bottom/wing tanks, the #2 tanks were double bottoms tanks.

Aft of the #3 fuel oil tanks were the engine room bilges. Along the port side of the engine room bilge was an oily water tank, a waste oil tank, a fuel oil day tank, and a lube oil tank. Along the starboard side of the engine room bilge was a fuel oil day tank, a dirty oil tank, and a lube oil tank.

Aft of these tanks and below the hydraulics room were the #4 port and starboard double bottom/wing fuel oil tanks. These tanks were not symmetrical nor did they meet at the centerline, creating a much deeper asymmetrical bilge pocket between them.

Inboard of the aft end of the #4 fuel oil tanks were narrow voids and two potable water tanks. Aft of the potable water tanks was the rudder room and the port and starboard aft ballast tanks.

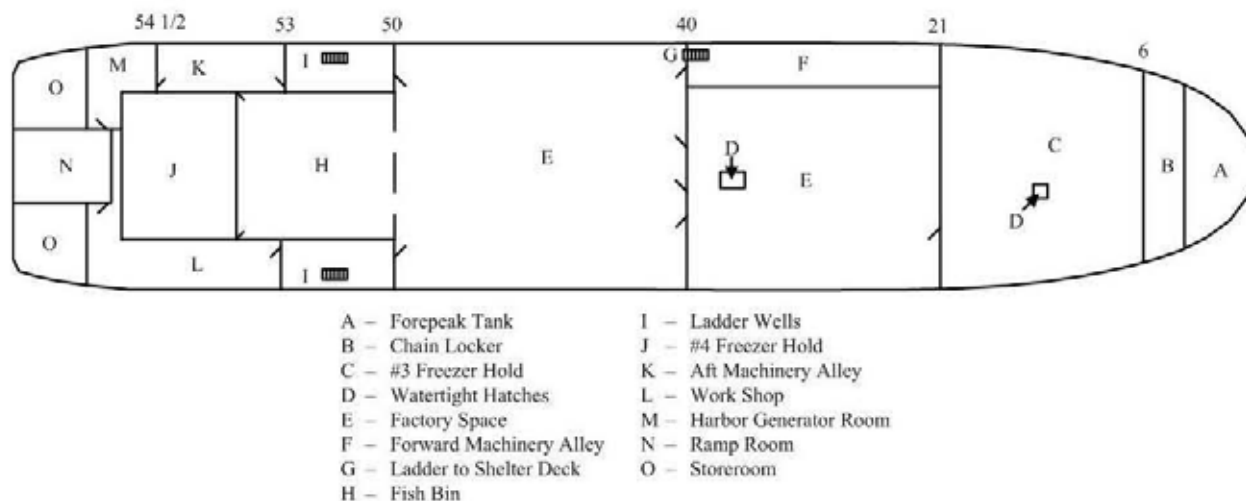

Note: Figure is not to scale.

Figure 6: Main Deck

The main deck, also known as the factory deck, was above the hold deck. The chain locker was aft of the forepeak. Aft of the chain locker was the #3 freezer hold, which was accessed through an insulated door from the factory and contained a watertight hatch that measured 3 feet x 3 feet and led to the holds below.

The factory, which was aft of the freezer hold, comprised the majority of the factory deck. It contained four plate freezers, a watertight hatch that measured 4 feet x 6 feet and led to the freezer holds below, and a system of conveyors and equipment used to process catch. Entrances to the factory included two watertight doors in the aft bulkhead, port and starboard, as well as a ladder, portside forward, leading up to the interior of the shelter deck. Along the port side of the forward portion of the factory was the forward machinery alley. It contained the marine sanitation device, the 480V to 240V and 480V to 120V step-down transformers and the breaker panels for the transformers and the 240V and 120V loads.

The aft port and starboard watertight doors led to ladder wells to adjacent decks. The portside ladder well had a ladder up to an exterior quick acting watertight door that opened onto the trawl deck. A watertight door led aft into the aft machinery alley. Aft of the aft machinery alley, through a second watertight door, was the harbor generator room, containing the harbor generator set. These spaces lay outboard of the fish bin and the #4 freezer hold.

On the starboard side, a ladder led up to an exterior quick acting watertight door onto the trawl deck while a ladder also led below to the engine room on the hold deck. A watertight door led aft into the work shop. Each ladder well was enclosed by two watertight doors on the main deck, one leading forward and the other aft.

The fish bin and #4 freezer hold were aft of the factory. In the stern quarters were port and starboard storerooms. These were added at the time of the conversion as fuel tanks and were later converted into storerooms. The hatches into these storerooms were located on the trawl deck. On centerline and between the storerooms, directly under the stern ramp and above the

rudder room, was the ramp room. The ramp room had port and starboard watertight doors that opened to harbor generator room and starboard work shop, respectively. Between the ramp room and the #4 freezer hold was a small, narrow space open on the starboard side and enclosed on the port side with a bulkhead that was not believed to be watertight.

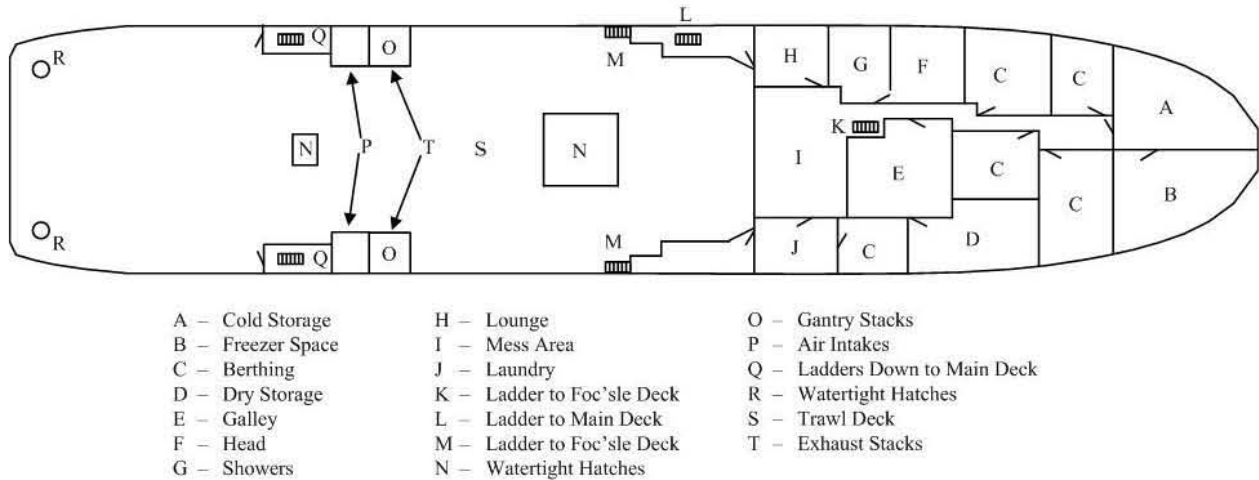

Note: Figure is not to scale.

Figure 7: Shelter Deck

Above the main deck was the shelter deck. The shelter deck was comprised of the house and the trawl deck. The trawl deck was bounded by bulwarks six feet high from the house to the stacks and eight feet high from the stacks to the stern ramp. Large freeing ports were spaced along the length of the bulwarks. Inboard of the bulwarks were fish bulwarks that extended forward from the stern ramp towards the house. These fish bulwarks were 39 inches high with cutouts for personnel access. The trawl deck had two watertight hatches. The aft hatch was used to drop catch into the fish bin, and the forward hatch, which led into the factory, was used to offload processed catch.

The house was accessed by port and starboard doors leading to interior passageways and contained the crew’s mess area, the galley, berthing areas and storage compartments.

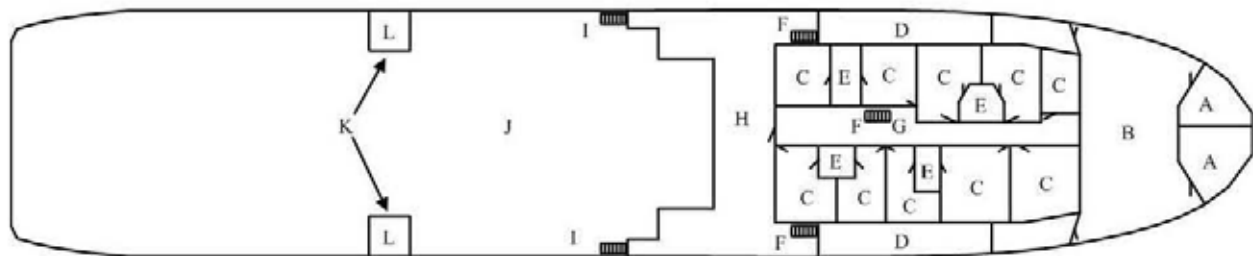

- | | |
|---------------------------------|----------------------------|
| A - Ships Stores | G - Ladder to Shelter Deck |
| B - Forward Weather Deck | H - Weather Deck |
| C - Berthing | I - Ladders to Trawl Deck |
| D - Passageways | J - Trawl Deck |
| E - Heads | K - Exhaust Stacks |
| F - Ladders to Pilot House Deck | L - Gantry Stacks |

Note: Figure is not to scale.

Figure 8: Foc'sle Deck

The foc'sle deck was above the shelter deck. It contained more berthing spaces and a ladder leading to the pilot house. The weather deck was accessed through a centerline door in the aft bulkhead, and exterior port and starboard ladders led down to the trawl deck and up to the pilot house.

Forward of the house was the forward weather deck, enclosed by bulwarks 56 inches high and by two small raised store rooms. Access was through port and starboard passageways outboard of the house. At the forward end of the passageways were weathertight doors that led onto the bow.

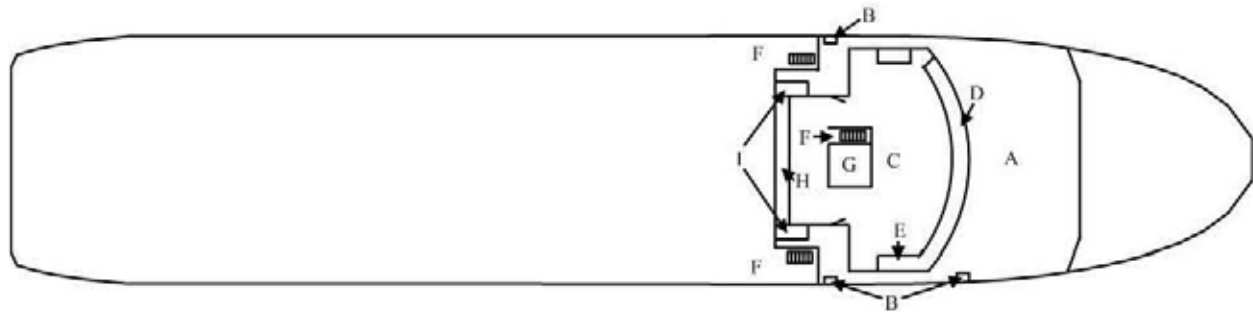

- | | |
|--|--------------------------------|
| A - Weather Deck | F - Ladders to Foe'sle Deck |
| B - Liferafts | G - Chart Table |
| C - Pilot House | H - Conning and Winch Controls |
| D - Conning Controls and Instrumentation | I - Survival Suit Storage |
| E - Electronics Console | |

Note: Figure is not to scale.

Figure 9: Pilot House Deck

Above the foc'sle deck was the pilot house deck, consisting of a forward weather deck and the pilot house. The pilot house was arranged with a console across the forward bulkhead containing conning controls and instrumentation. An electronics console was installed on the starboard bulkhead and a settee was located on the port side. In the center was an island with a settee, table and chart table. A console across the aft bulkhead contained conning and winch controls. The weather deck was accessed through port and starboard doors. Windows were in all four bulkheads. The weather deck was enclosed by a 42 inch high guard rail.

Engineering

The vessel was equipped with two Nohab Polar, 16 cylinder, 3520 HP, turbocharged diesel engines, each driving a Bird-Johnson, 120 inch diameter, controllable pitch propellers (CPP) with Kort nozzles through Western Gear Co. 3.48:1 reduction gears. The engines were air started and cooled by channel-type keel coolers.

Each of the two tailshafts was 10 inches x 38 feet and supported by water lubricated stern and strut bearings. The tailshaft passed through the hull aft of the hydraulics room. The vessel was outfitted with two rudders. The upper stock of each rudder had an outside diameter of 9.25 inches in way of the upper bearing, and the upper bearing was capped by a locking ring with an inner diameter of 8.625 inches.

Each diesel engine drove a Stanford, 750 kW, AC generator via a Norgear power-takeoff. The vessel was also equipped with three independent auxiliary diesel generators. One 800 kW Caterpillar generator and one 600 kW Caterpillar generator were located in the engine room and one Delco 150 kW generator, referred to as the harbor generator set, was located in the harbor generator room.

According to a report produced by an independent marine surveyor on 9 July 2006, the engine room contained two 10 HP bilge/ballast pumps located forward of the main engines and two 15 HP CPP hydraulic pumps mounted below the deck plates at the aft end of the engine room.

Controllers for the CPP hydraulic motors were mounted on the aft bulkhead of the engine room. Two 40 HP steering gear hydraulic pumps were also located at the aft end of the engine room. One fire pump and other standard auxiliary machinery systems including fuel, oil, bilge, and air receivers and compressors, were in the engine room.

The hydraulics room contained refrigeration units for the fish holds and hydraulic system components for the various booms and winches used to handle the fishing gear. The hydraulic system components for the fish bin deck hatch were located on the port side of the factory deck forward of the harbor generator. Similarly, hydraulic system components for the factory were located on the starboard side of the factory deck in the work shop.

The 9 July 2006 report also stated the hydraulics room also contained two 40 HP sea water service pumps, one 10 HP sea water general service pump, one 3 HP bilge pump, one 2 HP trash pump, and two 15 HP factory emergency dewatering pumps.

Subsequent Hull Modifications

In 1991, an outer transom was added over much of the transom. It was comprised of a series of external frames attached on the port and starboard sides of the transom, outboard of the ramp, and covered by a layer of plating. Its purpose was to absorb impacts from the fishing gear and protect the actual stern shell plating. This installation created shallow voids that were too small to enter or inspect. Though these voids are not shown on any vessel drawings, they can be seen in photographs and their presence was noted by the vessel's shore side engineers and corroborated by USCG personnel.

The MBI heard conflicting testimony regarding bottom arrangements in the stern. One of the vessel's shore side engineers testified a double bottom void was fitted in way of the rudder room, including the passageway that runs forward between the fresh water tanks to the hydraulics room. He indicated the void was added as a protective measure after another FCA vessel grounded and experienced flooding in the stern. However, the compartment is not shown on any vessel drawings and other people familiar with the vessel testified there was no such double bottom or void space below the rudder room. The MBI determined there was insufficient evidence to conclude the double bottom void existed. Had it been installed, it would have been too small to enter and inspect.

Vessel Personnel

This section discusses the four primary categories of crew members on board the vessel at the time of the casualty. For a listing of each person's position and training, see Appendix A.

Officers

There were two deck officers on board the ALASKA RANGER, the Captain and the Mate.

The Captain stood the day watch in the pilot house (0700 to 1900). He was hired by FCA on 6 November 1985. He had periodically sailed on the ALASKA RANGER as a licensed officer for

a number of years. He had most recently joined the vessel on 4 February 2008 and served as the mate, but had been serving as Captain since 5 March 2008. He was a licensed Master of Uninspected Fishing Industry Vessels of not more than 2000 GRT upon “near coastal waters,” which is limited to ocean waters not more than 200 miles offshore. His license was last renewed on 25 April 2005, and it was his 7th issue².

The Mate stood the night watch in the pilot house (1900 to 0700). He had been employed by FCA since 13 March 1992 and had worked on all of FCA’s fishing vessels, sailing on the ALASKA RANGER as mate on a number of occasions over the years. He had most recently joined the ALASKA RANGER on 5 March 2008. He was a licensed Master of Uninspected Fishing Industry Vessels of any gross tons on oceans routes. His license was last renewed on 23 September 2003, and it was his 6th issue.

The Captain and the Mate had worked together before. The Captain was selected to serve as master of the ALASKA RANGER in March 2008 because he was more familiar with NMFS regulatory record keeping requirements associated with the vessel’s fishing operations.

There were three engineers on board the ALASKA RANGER, the Chief Engineer, the Day Engineer, and the Night Engineer.

The Chief Engineer was responsible for maintenance on board the vessel and did not stand watch. He had worked for FCA in 1994 before moving to Trident Seafoods, and returned to FCA in 2007. He joined the ALASKA RANGER on 2 January 2008. He was a licensed Chief Engineer of Uninspected Fishing Industry Vessels of not more than 6000 horsepower (4500 KW). His license was last renewed on 20 January 2006 and it was his 8th issue.

The Day Engineer stood the day watch (0700 to 1900) in the engine room. He was new to FCA and the ALASKA RANGER, having been hired on 8 January 2008. He had worked in the fishing industry for 35 years and was a licensed Assistant Engineer of Uninspected Fishing Industry Vessels of not more than 4000 horsepower (3000 KW). His license was last renewed on 17 May 2006, and it was his 3rd issue.

The Night Engineer stood the night watch (1900 to 0700). Having served on board for approximately 13 years, he had extensive experience on the ALASKA RANGER. He did not hold a license or merchant mariner’s document.

Foreign Fisheries Specialists

There were five Japanese nationals on board the ALASKA RANGER when it sank: the Fish Master, the Japanese Chief Engineer, and three technicians.

² The USCG places an issue number on a mariner’s license representing the number of total licenses in a particular category (deck, engine, radio, etc.). A mariner receives the next higher number if a license is upgraded or renewed, and a license must be renewed every 5 years.

The Fish Master supervised the fishing operations on board the vessel. The Japanese Chief Engineer managed the maintenance of the refrigeration plant, hydraulics for the fishing equipment, and factory equipment. The Japanese Technicians assisted with fishing activities and maintenance of the refrigeration plant and fishing gear.

The Japanese nationals were employees of North Pacific Resources, Inc., a Washington state corporation that buys the fish that FCA vessels catch. North Pacific Resources is in turn a subsidiary of Anyo Fisheries Co., Ltd., a Japanese owned company. The Japanese crew members are paid by North Pacific Resources, and FCA is billed for their cost. Some have Lawful Permanent Residency, or “Green Cards,” and others have work visas. A letter from North Pacific Resources to the Consulate General of the United States at the U.S. Embassy in Tokyo, Japan states the purpose of the Fish Master is to ensure the “harvest of adequate numbers of the desired target species”.

When the Japanese foreign fisheries specialists are on board FCA vessels they communicate with FCA, North Pacific Resources and Anyo Fisheries regarding fishing results and the state of the fish markets.

Factory Workers/Deck Hands/Stewards

The crew included 32 people that worked in the factory space. Factory workers were divided into three groups and each group worked for 12 hours, followed by 6 hours off. The groups continuously rotated through the factory, which operated 24 hours a day to process catch.

Two groups worked in the factory at any given time. Every six hours, one group was beginning its 12 hour shift, the second was half way through their shift, and the third was coming off duty having just finished their 12 hour shift.

The amount of experience the factory workers had ranged from several years to just a couple days. One factory worker with no prior fishing vessel experience had joined the ALASKA RANGER in Dutch Harbor only two days before the casualty.

Some of the factory crew had additional position titles and responsibilities such as bosun and deckhand. These people worked on deck during fishing operations, but also worked in the factory between fishing operations.

The ALASKA RANGER carried a chief cook, an assistant cook, and a steward. In addition to preparing meals, they did general cleaning and assisted the officers as necessary.

National Marine Fisheries (NMFS) Observers

The ALASKA RANGER was required to carry two NMFS observers. Observer #1 boarded the ALASKA RANGER on 19 March 2008. Observer #2 boarded the ALASKA RANGER on 4 March 2008. The NMFS Observers were stationed aboard the ALASKA RANGER and the other fishing vessels in the Bering Sea/Aleutian Island fisheries to collect and document data

used for fishery and protected species conservation and management and to monitor compliance with existing Federal regulations.

Factory Operations

When the catch was brought aboard, the cod end of the net was released and the catch was dumped through a hatch in the trawl deck into the fish bin aft of the factory. The catch flowed in from the fish bin to the observer's station, where the NMFS Observer conducted sampling to estimate the ratio of prohibited species to the target species and collected other fisheries related data. After passing the NMFS Observer, the catch was weighed on the flow scale, an addition to the factory mandated by regulation, that weighed each haulback.

After passing over the flow scale, the prohibited species were separated from target species and returned to the sea via the discard chute. The remaining catch continued through the factory on a conveyor belt. The heads were removed with electric saws to make the fish attractive for sale, and the fish were gutted. At the packing table, the headed and gutted fish were sorted by species and placed on freezing pans. With approximately 40 lbs of fish in each pan, they are pressed to make the fish "tight" and "flash" frozen in plate freezers.

Once frozen, the fish were removed from the pans by a process called "cracking," whereby the factory workers flipped the plates over and knocked the fish out onto the packing table. An ice glaze was applied by spraying water on the fish, which were then bagged and loaded into the freezer holds.

Weather

At 0201 on 23 March, the Mate on the ALASKA RANGER called the Mate on the ALASKA SPIRIT using the satellite telephone. During their conversation, the Mate on the ALASKA RANGER reported the winds were 30-35 knots, the swell was not very big, and the vessel was riding fine.

The HH-60 from Saint Paul Island arrived on scene at 0505 on 23 March and recorded the weather as follows:

Wind Speed:	25-30 knots
Wind Direction:	North
Air Temperature:	12 degrees Fahrenheit
Wave Height:	20-25feet
Heavy Snow Squalls	

The HH-65 and the CGC MUNRO noted the weather to be as follows:

Wind Speed:	26 knots, with gust of 35 knots
Wind Direction:	North West
Wave Height:	15-20 feet
Visibility:	5 nautical miles

Water temperature 32° Fahrenheit
Periodic Heavy Snow Showers

Additional detailed weather data is provided in Appendix 2.

The Casualty

Background

At the conclusion of the 2007 fishing season, the ALASKA RANGER traveled to Japan and underwent a shipyard repair period in October and November. In December 2007 the ALASKA RANGER returned to Dutch Harbor to await the 2008 fisheries seasons.

Between 19 January and 18 March 2008, the vessel made five fishing trips, returning each time to Dutch Harbor to offload the catch. It departed again on 19 March 2008, but only fished briefly, getting only four haul backs. It returned to Dutch Harbor on 22 March for a brief stop to change its fishing gear and load additional stores and fuel oil, but did not offload the fish caught between 19 and 22 March.

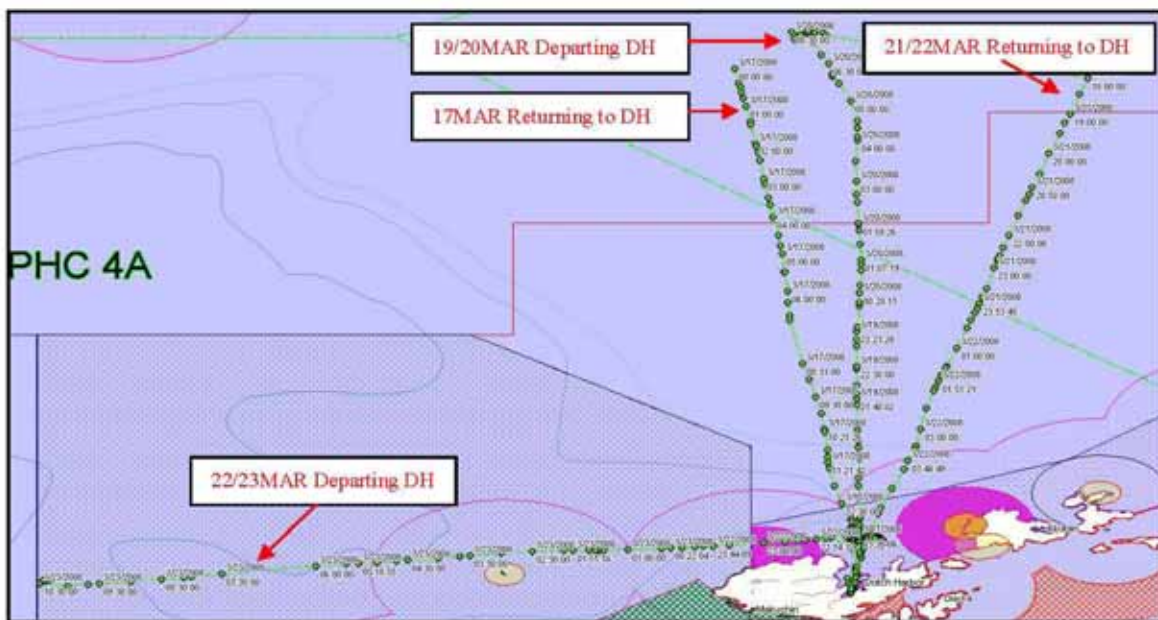

Figure 10: Vessel Trackline for 17 to 23 March (Provided by NMFS and based on VMS data)

The ALASKA RANGER got underway at 1210 Alaska Daylight Savings Time (all times ADT) on 22 March and began heading nearly due west with the Captain and the Day Engineer on watch. The vessel drafts were approximately 16.2 feet forward and 19.5 feet aft. At the stern, the main deck and overhead of the rudder room were approximately 1 foot below the waterline. Figure 10 shows the transit north from Dutch Harbor on 19 March and the return trip south on 22 March, as well as the trackline going nearly due west from Dutch harbor on its last voyage.

Once underway the crew rigged the nets, stowed stores, set up the factory space for operations, and otherwise prepared the ship for the next fishing evolution. Once done, they were free to rest and relax during the transit so they would be ready when fishing resumed. Some crew members watched movies and some slept.

At 1900 the Mate and the Night Engineer relieved the Captain and Day Engineer.

The Alarm

At approximately 0201 on 23 March 2009, the Mate on the ALASKA RANGER called the Mate on the ALASKA SPIRIT on the vessel's marine satellite telephone system (Inmarsat). During their conversation, which ended at 0226, the Mate on the ALASKA RANGER did not report any difficulties.

The Night Engineer testified that he was in the engine room making a logbook entry when the rudder room high water bilge alarm sounded. He went to the alarm panel in the forward end of the engine room, silenced the alarm, and then proceeded aft through the engine room and hydraulics room to the rudder room to investigate. The Night Engineer testified that as soon as he looked into the space, he saw a significant amount of water rapidly coming toward him, and closed and dogged the door. Using a phone in the hydraulics room, the Night Engineer called the Mate on watch in the pilot house, reported major flooding in the rudder room, and told the Mate to sound the general alarm. The Night Engineer then called the Chief Engineer and informed him of the flooding.

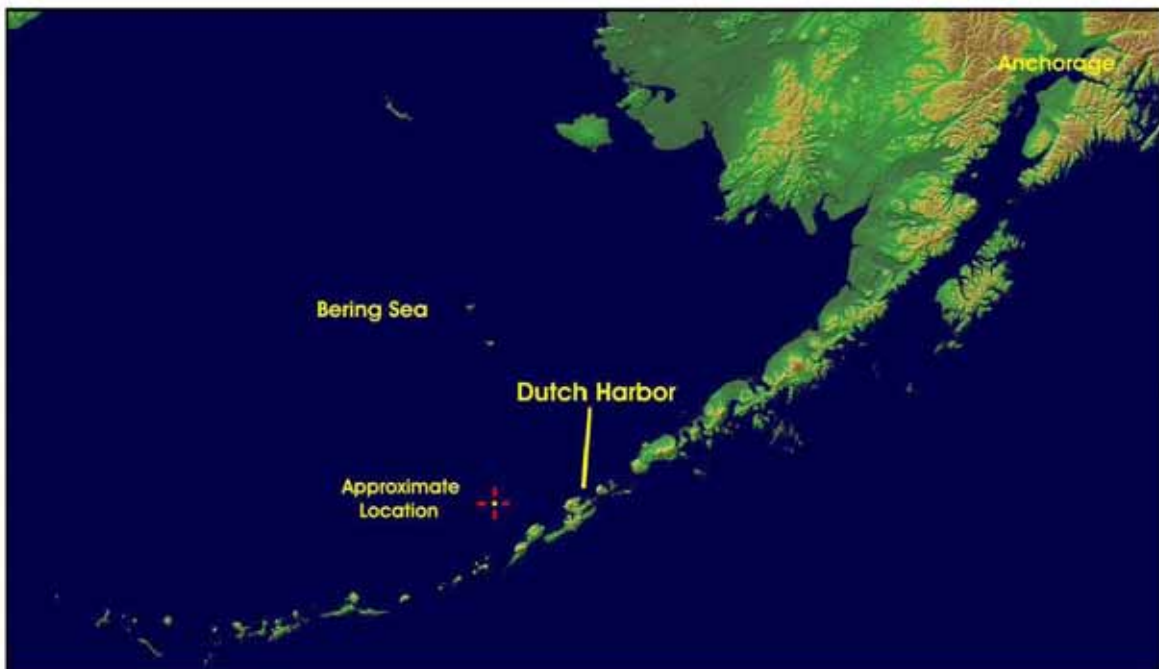

Figure 11: Reported position of the ALASKA RANGER at the time of the casualty.

In the hours preceding the alarm, and during the time that elapsed before the crew abandoned ship, no one heard any unusual noises or sounds. Similarly, no one felt any strange vibrations. With the exception of sudden significant flooding, there were no obvious indications of a collision, explosion, or other catastrophic failure.

Damage Control

At approximately 0230 the Mate sounded the general alarm. At 0236, the Mate called the ALASKA SPIRIT on the satellite telephone and reported they were taking on water.

The Night Engineer went to the forward end of the engine room, opened the bilge suction valves for the rudder room, hydraulics room, and engine room. One of the bilge pumps was already running to provide sea water to the incinerator. The Night Engineer testified he started the second electric bilge pump and left the sea suction open to provide a prime to the pumps and prevent them from running dry and overheating.

The Night Engineer went to the pilot house and reported to the Mate, then returned to the engine room with the Japanese Chief Engineer. They found water leaking around the edges of the rudder room door. Together, they secured power to the hydraulic equipment in the hydraulics room and hammered the dogs on the rudder room door to seal the door more tightly. Their efforts stopped most of the leaking from around the watertight door, but there was some minor leakage from a bulkhead penetration located above the door.

The Mate told the Bosun and the Factory Manager there was flooding in the rudder room and instructed them to head aft to assist. The Bosun and the Factory Manager, who were members of the emergency squad, went aft to get the portable diesel dewatering pump, which was stored in the starboard side workshop. The pump had a 2 inch inlet and discharge and was rated for a maximum flow rate of 150 GPM and a maximum lift of 25 feet.

The Bosun and Factory Manager did not see any water in the factory space, but found water on deck while passing through the harbor generator room, ramp room, and workshop. Because there was water in the work shop, they took the portable pump with them and went forward to search for a dry location to set up the pump.

The Factory Leader, also a member of the emergency squad, heard the Mate report flooding to the Bosun and the Factory Manager. He retrieved his boots and went aft to assist. He went through the factory space and aft to the workshop. As he was gathering the suction hose for the pump, he decided to check on the extent of the flooding and continued aft through the workshop. As he reached the door to the ramp room, the Factory Leader could see through the ramp room and into the harbor generator room, where he saw water striking against the port bulkhead and splashing behind the harbor generator.

Approximately ten minutes after the rudder room high water bilge alarm sounded, five of the men in the emergency squad began to set up the portable dewatering pump in the ladder well forward of the starboard side work shop.

A few moments later, the Chief Engineer, the Night Engineer and the Japanese Chief Engineer came up the ladder from the engine room and directed the emergency squad to head to their muster stations and prepare to abandon ship. The crew did not finish setting up the portable dewatering pump, and no one attempted to start it and use it to dewater any of the spaces.

The emergency squad and Chief Engineer went to the pilot house, while the Night Engineer and Japanese Chief Engineer went aft to the ramp room. The ramp room was filling with water and the water was flowing over the watertight door coaming into the work shop. They were unable to see where the water was coming from. The Night Engineer testified they closed the port side ramp room watertight door, but did not close the watertight door on the starboard side. They heard “popping” and believed the electrical transformers in the ramp room were becoming submerged in the water and posed a significant risk of electrocution.

The Night Engineer and Japanese Chief Engineer proceeded forward on the starboard side and closed and hammered tight the dogs on the watertight door at frame 53, which separated the work shop from the ladder well.

On their way back to the pilot house, the Night Engineer and the Japanese Chief Engineer checked the factory overboard discharge chutes and ensured they were tight.

With the crew out of the engine room and mustered in the pilot house, testimony indicates only the starboard side watertight door to the ramp room (frame 57 ½) was left open. All other watertight doors on the hold deck and main deck were closed. Specifically, on the port side main deck, the watertight doors separating the harbor generator room and aft machinery alley (frame 56 ½), aft machinery alley and port ladder well (frame 53), and port ladder well and factory space (frame 50) were closed. Similarly, on the starboard side main deck, the watertight doors separating the work shop and starboard ladder well (frame 53) and starboard ladder well and factory space (frame 50) were closed. The watertight door that separated the rudder room and hydraulic space (frame 54) was the only door installed on the hold deck, and it was closed.

In the pilot house, the Japanese Chief Engineer reported to the Fish Master. The Fish Master sent the Japanese Chief Engineer and one of the Japanese Technicians back to the engine room three or four times to check on the extent of the flooding. Entering the starboard ladder well via the watertight door on the shelter deck (frame 52), they went below and observed the water level in the engine room bilges.

The Japanese Chief Engineer testified the water level in the engine room bilges was steadily rising. On his last trip to the engine room, which he estimated was 20 minutes before the lights went out, the water level in the engine room bilges between the main engines was approximately seven feet. At this time, the vessel had not assumed a noticeable list.

At approximately 0253 the ALASKA RANGER reported it had lost steering. At approximately 0332 the ALASKA RANGER reported to the USCG that it had lost its lights and they were operating with emergency lighting. The loss of steering and lights may have been the result of electrical systems shorting out due to flooding or circuit breakers being opened by the Night Engineer.

Using flashlights, the Captain and the Night Engineer went below to check the engine room and confirm the starboard watertight door on the shelter deck was closed. They proceeded aft through the factory space, which had no water in it, and entered the starboard ladder well. The Night Engineer went up the ladder to the shelter deck, while the Captain went down to the engine room. The Night Engineer found the starboard water tight door at frame 52 open and the trawl deck aft of the door at frame 52 was largely submerged. After closing the door and returning down the ladder, he met the Captain as he emerged up the ladder from the engine room.

The Night Engineer testified the Captain told him the engine room bilges were dry. Together, they proceeded to return to the pilot house. When they got to the top of the ladder, and were about to enter into the pilot house, the vessel suddenly rolled to starboard and assumed a substantial starboard list. The Captain and Night Engineer donned their survival suits. The crew began to abandon ship.

Crew Muster

When the general alarm sounded, the majority of the crew members were in their rooms or in the galley. Several crew members went room to room and woke up their shipmates and alerted them to the situation; at least one crew member who was awakened acknowledged having heard the alarm and falling back to sleep. The crew members who were not in the emergency squad went to the pilot house.

The survival suits were stored together in deck boxes outside the pilot house. Each survival suit was stowed in an individual bag and the color of the bag was supposed to indicate the size of the suit. Specific suits were not assigned to specific crew members to match their individual size or build.

The crew distributed and donned survival suits in an orderly fashion. The NMFS Observers did not don survival suits from the vessel; each donned the survival suit they had brought when they reported on board.

To assist with muster and account for the crew, the Chief Cook and the Factory Leader both attempted to retrieve the muster sheets stored in the pilot house. They were unable to remove the sheets from their storage holders because the gloves on the survival suits limited their dexterity. The Chief Cook used a pencil or pen to tear down the holders and obtain the sheets. The Factory Leader attempted to use the muster sheets to account for crew members assigned to liferafts #1 and #3, but discovered they were not up to date and did not accurately reflect the current crew. Fortunately, due to his position on the vessel he was familiar with who was on board and was able to account for personnel.

After donning their suits, the crew members initially stayed in the pilot house. Due to noise and cigarette smoke, the Captain had everyone muster on the weather deck outside the pilot house. To help them stay warm, the Chief Cook asked and received permission for crew members to return to the pilot house in small groups. Before the crew was forced to abandon ship, three groups of five were able to rotate through the pilot house, each staying approximately five minutes to get warm.

Abandon Ship

Mustered in the pilot house and adjacent weather decks with their survival suits donned, crew members watched as the freeboard at the stern steadily decreased. Eventually, the stern was awash and fishing nets and gear were swept off the trawl deck by waves. The lights went out, likely because the vessel lost power. The emergency lights were powered by batteries and remained lit.

With the main engines still running, the controllable pitch propellers had gone to astern pitch, and the ALASKA RANGER began going astern before the liferafts were launched. The precise moment this occurred is uncertain.

After the vessel suddenly rolled to starboard, the Captain and Mate began telling the crew to abandon ship. At 0402, the ALASKA RANGER reported to COMMSTA Kodiak that the crew was abandoning ship at that time.

On the port side, liferaft #2 was pushed over the side of the vessel, but did not initially reach the water. The liferaft canister was seen hanging over the port side, suspended by the sea painter. The sea painter parted when crew members pulled on it in attempt to inflate the raft.

On the starboard side, liferafts #1 and #3 were launched. Liferaft #1 inflated and shot past the bow, where it was towed as the ALASKA RANGER was backing down. The sea painter parted under the strain. Liferaft #3 also inflated and travelled past the bow, and the sea painter remained intact. The Chief Cook ripped the palms of the gloves on his survival suit while unsuccessfully attempting to pull the liferaft alongside so they could embark. Several crew members went aft to the intended embarkation area, located near the gantry, but since neither of the starboard liferafts was alongside the vessel at this time they could not be entered directly from the vessel.

The main engines shutdown shortly after the liferafts were launched. With the ship no longer going astern, the three liferafts drifted toward the ALASKA RANGER.

At 0416, the ALASKA RANGER stated they had lost the liferafts and the crew was going to stay with the vessel. At approximately 0424, they reported two people had gone overboard and the vessel was listing 45° to starboard.

Due to the starboard list and flooding, there was little freeboard on the starboard side and the upper decks were near the water's edge. Most crew members either climbed down the embarkation ladder or jumped directly into the water. One crew member was able to jump directly into a liferaft. Some followed a sea painter to help them reach a liferaft. Crew members that managed to board liferafts quickly after entering the water shouted out over the water in an attempt to alert others to the location of the liferafts. In one instance, three crew members worked together to drag a near unconscious shipmate into a liferaft.

Before being rescued, 22 people managed to board two liferafts. The other 25 crew members never entered a liferaft. Some crew members in the water joined together, while others drifted

alone. The people in the water and liferafts became separated as the seas and winds affected them differently.

The Chief Engineer entered the water with the Day Engineer, but they quickly drifted away from each other. No one reported seeing the Captain or Mate abandon ship. The Japanese Technicians testified that the Fish Master led them to the rail and directed them to a liferaft.

The vessel was listing significantly to starboard, and the entire trawl deck was submerged when the crew abandoned ship. Just before it slid below the surface, the vessel was perpendicular to the water's surface, with the bow and pilot house visible above the water. Shortly after 0430, the ALASKA RANGER sank.

Search and Rescue

At 0242, the Mate on the ALASKA SPIRIT phoned the Mate on the ALASKA WARRIOR, another fishing vessel owned and operated by the same company as the ALASKA RANGER, and informed him that the ALASKA RANGER was taking on water. The ALASKA WARRIOR, which had departed Dutch Harbor a few hours after the ALASKA RANGER and was also en route to Petrel Bank, transited at best possible speed to lend assistance.

At 0248 on 23 March 2008, COMSTA Kodiak received a report from the ALASKA RANGER over the 2182 kHz distress frequency and informed the D17 Command Center, which is the North Pacific Search and Rescue Coordinator (NPSC) and Search and Rescue (SAR) Mission Coordinator for the Bering Sea. The vessel was taking on water in position 53-53N 168-58W, approximately 130 miles west of Dutch Harbor, AK.

At 0254, D17 directed USCG AIRSTA Kodiak to launch a USCG HC-130 fixed wing aircraft that had been repositioned at Elmendorf Air Force Base in Anchorage because inclement weather was anticipated in Kodiak. In addition, D17 directed preparations be made to launch a USCG HH-60 helicopter deployed to Saint Paul Island in the Bering Sea.

Though normally stationed in Kodiak, the HH-60 was positioned Saint Paul for approximately three months during the busy fishing season to facilitate a quicker response to search and rescue cases occurring in the Bering Sea. As a result, instead of being over 600 NM away the HH-60 only had to travel approximately 197 NM to reach the ALASKA RANGER. From Elmendorf Air Force Base, the HC-130 was approximately 779 NM from the scene.

At 0258, COMSTA Kodiak commenced a regular communications schedule on five minute intervals with the ALASKA RANGER.

The CGC MUNRO was on patrol in the Bering Sea, steaming at a slow bell south of the Pribilof Islands, northwest of an approaching storm and to the north of most fishing vessel activity. The CGC MUNRO had taken this position to allow the approaching storm to pass to the south and allow them to follow behind the storm and get back to work conducting at sea fisheries boardings. Additionally, given the present sea conditions, the CGC MUNRO could transit south from this location more quickly if a fishing vessel needed emergency assistance.

The CGC MUNRO has twin shafts and a combined diesel or gas turbine propulsion plant, meaning each shaft can operate on either the main diesel engine or the gas turbine. However, the engine and the turbine cannot be operated together at the same time. When operating with the gas turbines the CGC MUNRO is capable of making up to 27 knots.

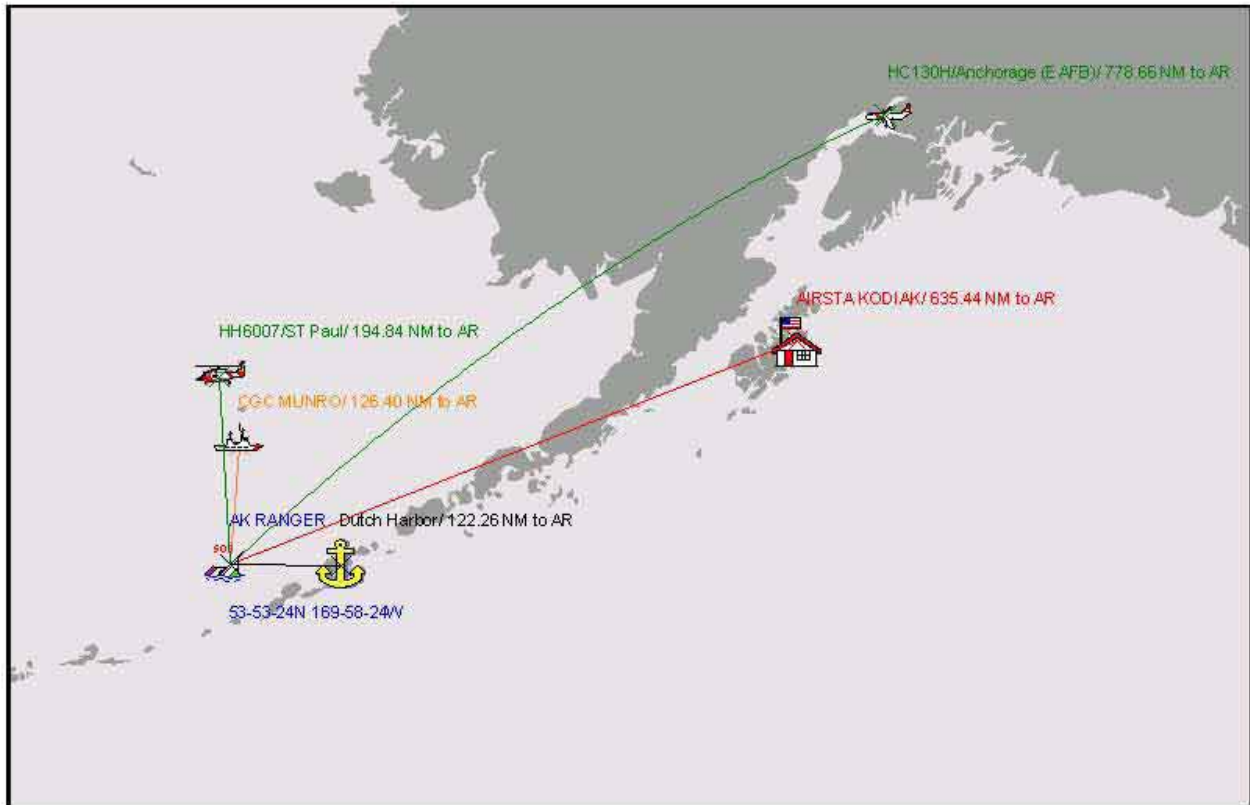

Figure 12: Relative distance of USCG response assets

At 0252, the CGC MUNRO heard a mayday call from the ALASKA RANGER over the 2182 kHz distress frequency. The CGC MUNRO was running on diesel engines, with gas turbines on five minute standby. They immediately shifted to the gas turbines and began transiting at best speed to intercept the ALASKA RANGER, which was approximately 127 NM to the south.

At 0259, D17 issued an Urgent Marine Information Broadcast (UMIB) over HF and VHF distress frequencies to alert mariners of the ALASKA RANGER's condition and requested they give assistance, if able.

At 0350, the HH-60, with a crew of four, departed Saint Paul en route to the ALASKA RANGER. The crew consisted of the Aircraft Commander, the Pilot, the Flight Mechanic, and the Rescue Swimmer. At 0356, the HC-130 left Elmendorf Air Force Base en route to the ALASKA RANGER.

At 0430, the HH-60 established communications with the ALASKA RANGER using the VHF radio. The Captain of the ALASKA RANGER reported the vessel was listing 45° and that he

expected it would soon capsize. The Captain also reported that only seven persons remained on board and all others had abandoned ship.

The HH-60 then established radio communications with the ALASKA WARRIOR, which was about 13 nautical miles east of the ALASKA RANGER at that time.

At 0505, when the HH-60 arrived on scene, there was no sign of the ALASKA RANGER.

The HH-60 initially spotted a couple of strobe lights and assumed they were the liferafts. However, as the HH-60 got closer, the aircrew saw additional strobe lights and soon realized the lights were attached to individuals as well as rafts. The Aircraft Commander estimated they saw at least 20 strobe lights. The HH-60 communicated with survivors in one liferaft that had a handheld VHF radio.

The HH-60 deployed its Rescue Swimmer and began hoisting survivors from the water, one at a time. The Aircraft Commander testified they rescued two persons that were floating together, followed by a group of six, another pair, and then a group of three. Upon completion of these hoists the HH-60 recovered the Rescue Swimmer. There was no more room for additional survivors in the helicopter cabin, which was approximately 10.8 feet long by 4.5 feet high and 6 feet wide.

With the cabin full and its Rescue Swimmer aboard, the HH-60 flew to the ALASKA WARRIOR, which was now only approximately 5 NM away, and attempted to lower the survivors at 0604. However, the crew of the HH-60 determined ALASKA WARRIOR did not have adequate open deck space to safely lower survivors and departed the scene en route to the CGC MUNRO at 0612.

Aboard the CGC MUNRO, the HH-65 aircrew began planning their mission as soon as they learned the ALASKA RANGER was taking on water. Based on the initial report received from the ALASKA RANGER, the HH-65 Aircraft Commander understood the vessel was taking on water and determined that launching when the CGC MUNRO was 60 miles from the ALASKA RANGER would optimally balance transit time and time needed on scene to deliver a dewatering pump. However, when the ALASKA RANGER reported they were experiencing uncontrollable flooding, he decided the circumstances dictated an earlier launch in order to arrive on scene sooner.

Having received a report that there were over 20 people in the water, the HH-65 Aircraft Commander planned to leave the Rescue Swimmer on scene with a liferaft and create additional room in the aircraft cabin so at least one additional survivor could be recovered from the water. The Aircraft Commander informed the Rescue Swimmer of the plan, and he donned an additional layer of clothing beneath his survival suit.

Though the pitch and roll of the CGC MUNRO were outside the safety limits prescribed by USCG flight procedures, the HH-65 successfully launched at 0555 when the CGC MUNRO was approximately 80 miles from the scene.

At 0620, the HC-130 arrived on scene, and the aircrew observed multiple strobe lights in the water. It served as on scene commander for the two helicopters. It also provided direction to the ALASKA WARRIOR, helping it locate and retrieve survivors from the life rafts.

At 0633, the HH-65 arrived on scene, deployed its Rescue Swimmer, hoisted a group of three survivors, recovered its swimmer, and headed toward another group of four survivors. However, since these survivors were waving their arms at the helicopter and appeared to be in good condition, the HH-65 went to assist the Day Engineer and Crew Member A, who were entangled in a fishing net and debris.

The HH-65 deployed its Rescue Swimmer and basket to recover the two men. He started with Crew Member A, who was unresponsive, and had great difficulty getting him properly positioned in the rescue basket.

Watching the Rescue Swimmer struggle for several minutes while trying to get Crew Member A into the basket, and aware that the HH-65 was getting low on fuel, the Flight Mechanic began hoisting the basket when it appeared Crew Member A was in the rescue basket. However, the Rescue Swimmer never signaled to the Flight Mechanic for the hoist to begin.

When the rescue basket reached the helicopter, Crew Member A was hanging onto the basket, but his legs and torso were dangling outside of the basket, and the Flight Mechanic could not bring the basket into the cabin. Due to the combined weight of Crew Member A and the water in his survival suit, the Flight Mechanic was unable to lift or pull Crew Member A from the basket into the cabin. As the Flight Mechanic turned to grab a knife or webbing cutter, also known as a shroud cutter, to cut and drain the water from the survival suit, Crew Member A slipped from the basket and fell to the water, approximately 40 to 60 feet below.

The Aircraft Commander saw Crew Member A floating face down in the water and did not see any movement. The Aircraft Commander attempted to attract the Rescue Swimmer's attention using a spotlight, but was unsuccessful. The Rescue Swimmer, who was swimming toward the Day Engineer, was approximately 70 yards from Crew Member A and could not see him due to the swells. When later recovered by the ALASKA WARRIOR, Crew Member A was deceased.

The HH-65 then recovered the Day Engineer. With four survivors in the helicopter, the Rescue Swimmer volunteered to remain behind, creating space for a fifth survivor. The HH-65 went back to the group of four survivors they had spotted earlier, deployed the Rescue Swimmer, and hoisted one of the four survivors.

At 0733, with five survivors aboard, the HH-65 dropped a liferaft for the Rescue Swimmer and departed for the CGC MUNRO. The Rescue Swimmer helped the three survivors into the liferaft and remained with them until they were recovered by the HH-60 approximately one hour later.

At 0644 the HH-60 arrived at the CGC MUNRO and began lowering the survivors using the rescue basket because the helicopter was too large to safely land on deck. The crew of the CGC MUNRO hurried the survivors to the mess deck for triage and treatment.

While en route, the HH-60 reported to the CGC MUNRO operations center that it had 13 survivors on board. However, during the transfer of survivors from the HH-60 to the CGC MUNRO, personnel on the bridge of the CGC MUNRO counted only 12 survivors lowered to the deck. No one on the bridge reported their count to the operations center, nor did the operations center ask the bridge for a count of survivors. As a result, the discrepancy went unnoticed.

At 0710, with the survivors disembarked from the HH-60, the CGC MUNRO and the HH-60 began preparations for helicopter in-flight refueling (HIFR).

At 0726, the ALASKA WARRIOR recovered a liferaft with 10 people on board. It had initially come alongside the liferaft with the intention of having the survivors climb aboard using the Jacob's ladder. This proved very difficult due to the conditions, and the survivors were eventually lifted from the liferaft using a harness and the vessel's crane.

At 0740, while the HH-60 was approximately half way through the refueling process, the HH-65 informed the CGC MUNRO it was critically low on fuel. The HIFR was immediately suspended, and the CGC MUNRO shifted to gas turbines and made best possible speed to intercept the HH-65 and minimize the distance the helicopter needed to travel. With enough fuel to fly for approximately four hours, the HH-60 departed the CGC MUNRO and arrived back on scene at approximately 0800.

As the HH-65 neared the CGC MUNRO, the cutter shifted back to the main diesel engines and turned into the wind to provide the best possible relative wind conditions for recovering the HH-65. The HH-65 safely landed on the CGC MUNRO with three aircrew and five survivors.

By 0809, the ALASKA WARRIOR had recovered 12 additional survivors from a second raft. One survivor was unconscious when he was recovered by the ALASKA WARRIOR, but revived and was walking after being warmed up.

By 0838, the HH-60 had recovered three more survivors and the HH-65's Rescue Swimmer. The HH-60 recovered the Mate, who was non-responsive, and then continued to search for other survivors. The HH-60 saw three liferafts, confirmed no one was in them, dropped a datum marker buoy to determine the "set and drift" of objects in the water, and departed for the CGC MUNRO.

At 0907 the HH-65 lifted off from the CGC MUNRO to allow the HH-60 to approach and transfer personnel. With the HH-65's Rescue Swimmer now aboard the HH-60, the Aircraft Commanders agreed the HH-65 would take the HH-60's Rescue Swimmer and return to the scene.

The HH-60 lowered four ALASKA RANGER crew members and both Rescue Swimmers to the CGC MUNRO. The crew of the CGC MUNRO attempted to revive the Mate without success. The HH-65 picked up the HH-60 Rescue Swimmer and departed at approximately 0955 to return to the scene.

By 1010 the ALASKA WARRIOR reported it had recovered the Captain, Chief Engineer, and Crew Member A from the water. They were found floating within 100 yards of each other. All three men were non responsive, and their shipmates' efforts to revive them were unsuccessful. The crew of the ALASKA WARRIOR had difficulty recovering the Captain because his survival suit contained a significant amount of water.

At 1010, believing 22 ALASKA RANGER crew members were on board CGC MUNRO and 25 were aboard the ALASKA WARRIOR, the CGC MUNRO reported to D17 that all 47 ALASKA RANGER crew members had been recovered. D17 suspended the search efforts.

At 1215, D17 determined that one person was missing. After collecting the names of the survivors aboard the CGC MUNRO and the ALASKA WARRIOR, D17 realized the Japanese Fish Master remained unaccounted for. Though they had reported they had 22, the CGC MUNRO actually only had 21 ALASKA RANGER crew members on board.

Search efforts immediately resumed using the CGC MUNRO, another HC-130, and the HH-60. At 2112 on 24 March 2008, the USCG's search for the missing crew member was suspended. Other fishing vessels continued to search for the missing crew member.

Of the 47 people on board the ALASKA RANGER, 42 were recovered and survived, four were recovered and were deceased, and one was never recovered and is presumed dead.

Owners and Operators

Owner

FCA Holdings Incorporated owned the ALASKA RANGER and has no employees. Adler Family Trust is the owner of FCA Holdings. The trustee and the beneficiaries of the trust are all U.S. citizens.

The Maritime Administration (MARAD) is the U.S. federal agency responsible for determining the veracity of the citizenship of owners of U.S. flagged vessels. On 10 December 2007, MARAD issued its annual determination that FCA Holdings continued to qualify as a U.S. citizen within the meaning of 46 USC 50501.

Operator

FCA Holdings also owns 100% of the Fishing Company of Alaska, Inc. (FCA). FCA operated the ALASKA RANGER and six other commercial fishing vessels, three trawlers and three long-liners. There are 21 shore-side FCA employees and approximately 250 employees aboard FCA vessels. Each trawler had approximately 42 crew members and each long-liner operated with approximately 27 U.S. crew members. Each FCA vessel also had an additional five Japanese nationals on board that served as foreign fisheries specialists and were not FCA employees.

The Operations Manager of FCA oversees the daily operations of the company's vessels, communicating frequently with crews on the vessels. He is also responsible for obtaining licenses and permits required by the state and federal government. Prior to becoming Operations

Officer in 2006, he sailed on the ALASKA RANGER for approximately 14 years. Before joining FCA, he had sailed as Master of the RANGER when it was an offshore supply vessel.

Third Party Examinations

Prior to 2006

As an offshore supply vessel, the RANGER was classed and assigned a load line when built in 1973. To enter into class, a vessel must meet the classification society's rules for design, construction, and operational maintenance. Entry into class normally involves technical plan review and design analysis, surveys during construction, subsequent periodic surveys, and surveys of damage, repairs and modifications. Load line assignment includes limiting the draft of the loaded vessel to reserve a portion of the hull's buoyancy above the waterline and confirming compliance with the "conditions of assignment," which ensures the watertight integrity of the vessel below deck and provides for crew safety while working on deck.

With the exception of 1985, ABS regularly conducted load line and class surveys on the RANGER for the maintenance of its classification and load line assignment before it was laid-up in the late 1980's. In addition, although some of the records appear to be incomplete, the RANGER was inspected by the USCG and maintained a valid Certificate of Inspection during a portion of this period. After it was converted to a commercial fishing vessel in 1989, the ALASKA RANGER was not classed, did not initially obtain a load line certificate, and did not operate as a USCG inspected vessel.

In a 7 November 1990 letter, Elliot Bay Design Group (EBDG), a naval architecture firm located in Seattle, WA, informed MSO Seattle, on behalf of FCA, that a "fillet line" was being added to the factory aboard the ALASKA RANGER and acknowledged that with this modification the vessel became a fish processing vessel.

In a 20 November 1990 letter from MSO Seattle, the USCG informed EBDG that since the vessel had been converted to a fish processing vessel after 1 January 1983 it was required to obtain a load line in accordance with 46 USC 5102. MSO Seattle also stated, "Additionally, this [major] conversion after July 27, 1990, requires that the vessel meet all survey and classification requirements prescribed by the American Bureau of Shipping in accordance with 46 USC 4503." The letter explained that "Major conversion is defined in 46 USC 2101(14a) and included 'a conversion ... that changes the type of the vessel.' ALASKA RANGER has been changed to a processor."

Year	Load Line Survey	Certificate of Compliance	Other Class Survey	ACSA Exam	USCG Voluntary CFV Exam	Other USCG Exam
1990	Red					
1991			Red			
1992	Red					
1993	Red				Red	
1994		Blue				
1995	Red					
1996	Red	Blue				
1997	Red					
1998		Blue				
1999						
2000		Blue				
2001						
2002		Blue				Blue
2003						Blue
2004		Blue	Red			Blue
2005						Blue
2006				Blue	Red	
2007				Blue		
2008			Red	Blue	Red	

Figure 13: Summary of Third Party Examinations

However, the ALASKA RANGER was never classed by ABS or any other recognized classification society after it was converted to a fish processing vessel. This is likely due to confusion over the applicability of the major conversion definition. Though the MBI did not find any signed correspondence reversing the decision and informing FCA that the ALASKA RANGER did not need to meet survey and classification requirements, an unsigned copy of the 20 November 1990 letter was found in USCG files with a handwritten note from the MSO Seattle Chief of Inspections stating “Change on policy – from F/V [fishing vessel] to processor is not a major conversion.”

The USCG reversed its interpretation at least one more time five years later. In October 1995, the Commandant stated the “addition of processing equipment aboard these vessels [fishing vessels] constitutes a major conversion” because it changes the vessel type.

The MSC makes major conversion determinations on a case by case basis, based on the criteria in 46 USC 2101(14a). In response to a query from the MBI, the MSC stated since both fishing vessel and fish processing vessel are well defined in 46 USC 2101, moving from the strict definition of one vessel type to another would likely be judged a major conversion. However, a determination involving a vessel such as the ALASKA RANGER, which changed from a vessel engaged in some processing activities to a vessel engaged in more extensive processing activities, is not possible without examining the details of such a change.

After conducting an inclining experiment, completing stability calculations, adding fixed ballast, and undergoing a load line inspection, the ALASKA RANGER was issued a provisional Load Line Certificate in December 1992. The certificate authorized the following minimum

freeboards, measured from the deck line: Tropical and Summer, 0 feet, 2 inches; Winter, 0 feet, 6 5/8 inches; and Winter North Atlantic – 0 feet, 8 5/8 inches. The load line was based, in part, on a Stability Letter issued by the MSC on 28 May 1992 that stated the stability was satisfactory for a summer load line assignment corresponding to a mean molded draft of 18 feet, 4 ½ inches.

Figure 13 provides graphic display of the third party exams and inspections conducted onboard the ALASKA RANGER from 1990 until 2008. The most recent Load Line Certificate was issued in June 1996 and, subject to successfully completing required annual inspections, would have been valid until 31 October 2000. However, because the last annual load line inspection was conducted in December 1997, the Load Line Certificate expired in 1998. The reason this occurred is unclear. According to FCA's Operation Manager, "I was not in the office or taking part in any of those decisions at that time, but I assume that the load-line lapsed then because it was not required to do business."

Per 46 CFR 28.710, unless subject to USCG inspection under a different subchapter in Title 46 of the CFR, a fish processing vessel must be examined for compliance with 46 CFR Subchapter C at least once every two years. The examination is to be conducted by the ABS, DNV, or another similarly qualified organization, or a surveyor of an accepted organization. If found to be in compliance with the applicable USCG regulations, a Certificate of Compliance is issued to the vessel owner or operator and a copy is forwarded to the cognizant USCG District Commander.

From 1994 to 2004, DNV regularly examined the ALASKA RANGER and issued a Certificate of Compliance. DNV did not conduct an exam or renew the Certificate of Compliance when it expired in 2006. The ALASKA RANGER received USCG voluntary dockside Commercial Fishing Vessel Safety (CFVS) Examinations in 2006 and 2008, was found to be in compliance with applicable regulations, and received a CFVS decal at each examination. However, in lieu of a voluntary exam, the ALASKA RANGER was required to maintain a Certificate of Compliance and should not have been issued a CFVS Decal from the USCG.

The ALASKA RANGER was regularly surveyed by an independent surveyor for insurance purposes to "ascertain the condition, valuation and suitability of the vessel for service." These surveys did little more than simply list the vessel's design and equipment details.

The most recent survey was completed on 6 July 2006. The surveyor's "Recommendations" were to repair stateroom smoke alarms, provide a safety guard for a bench grinder, post a placard regarding eye safety, and clean out the bilges. The surveyor was of the opinion that the vessel "will be in satisfactory condition and suitable for operation in the intended service." However, the report states the examination was made "without making removals, or opening up parts ordinarily concealed, or testing for tightness, or trying out machinery." Plating and decks "appeared generally well maintained with scattered indents and condition generally consistent with the age and service of the vessel." However, the "interior" plating, structural framing, and underwater portions of the hull and fittings, including the propellers, shafting, and rudders were not examined. The report stated "no determination of intact stability or inherent structural integrity has been made."

Recent Examinations

On 20 June 2006, the ALASKA RANGER received a preliminary exam for enrollment into the Alternate Compliance and Safety Agreement (ACSA). ACSA contains alternate requirements promulgated jointly by USCG Districts 13 and 17 on 15 June 2006. Eligible fish processing vessels that enroll and comply with the ACSA requirements are exempted from class and load line requirements.

The preliminary ACSA exam was conducted by the CFVS Examiner from the USCG Marine Safety Detachment (MSD) Unalaska. He has been a CFVS Examiner since January 1993 and does not hold any USCG marine inspection qualifications.

The scope of the exam on 20 June 2006 was expanded to include some elements of the ACSA program not normally covered during a voluntary CFVS Examination, but did not include any ACSA hull or machinery requirements. Three deficiencies related to ACSA were issued requiring additional fire hose for the portable fire/dewatering pump, one additional fireman's outfit and six additional spare SCBA bottles, and completion of the ACSA required stability booklet addendum. The MSD Unalaska CFSV Examiner testified he also informed the vessel operator the liferaft installation arrangements needed to be modified to permit launching by a single person and embarkation ladders were required. However, these additional requirements were not documented.

In November 2007, the ALASKA RANGER, the ALASKA JURIS, and ALASKA WARRIOR traveled to Yamanishi Shipyard in Ishinomaki, Japan, to undergo repairs and maintenance, make factory modifications, and receive the USCG drydock and internal structural examinations required for enrollment in ACSA.

The Sector Seattle CFVS Examiner attended the ALASKA RANGER in Japan and was designated as the USCG's Lead Marine Inspector (MI) for the ACSA drydock and internal structural examinations. Though not specifically stated in ACSA policy at the time, D13, D17, and Sectors Seattle and Anchorage agreed that only qualified marine inspectors had the experience and competencies necessary to conduct drydock and internal structural examinations on vessels enrolled in ACSA.

The Sector Seattle CFVS Examiner had nine years of marine safety experience while serving on active duty in the USCG, and holds several USCG marine inspection qualifications including Hull, Machinery, and Drydock Inspector. He was hired as a civilian CFVS Examiner in September 2006, and has been Chief of the Uninspected Vessel Branch at Sector Seattle since September 2007.

The Sector Seattle CFVS Examiner went to Japan twice while the ALASKA RANGER was in the shipyard. According to his testimony he was "on and off" the ALASKA RANGER over a period of 21 days in October, returned home for 5 days, then went back to Japan for another 11 days. During this period, he also conducted examinations on the other FCA vessels in the shipyard.

During his first visit, the Sector Seattle CFVS Examiner was assisted by one qualified MI from USCG Activities Far East (FEACT) and the MSD Unalaska CFVS Examiner, who attended as a trainee since he had no marine inspection qualifications. On his second visit, he was assisted by another qualified MI from FEACT. The FEACT MIs were unfamiliar with ACSA and attended to learn more about the program. The intent was to familiarize FEACT personnel with the program so that they could conduct future ACSA drydock examinations in Japan avoiding the need to send the Sector Seattle CFVS Examiner.

The Sector Seattle CFVS Examiner used the “Alternate Compliance Safety Agreement Checklist,” commonly referred to as the ACSA CG-840 book as a guide during the examinations. The USCG has developed CG-840 books for the inspections commonly conducted on inspected vessels. The small books contain a convenient and concise checklist of the applicable requirements, and are used by USCG marine inspectors during vessels inspections.

The ACSA CG-840 book requires that all internal spaces, voids, cofferdams, integral fuel oil tanks and ballast tanks be internally examined for wastage or damage. The narrative in the USCG’s casework for the examination of the ALASKA RANGER states, “Conducted an ISE [internal structural exam] of FWD [forward] ballast tank, Aft ballast tank and STBD [starboard] fuel tank, voids and cofferdams. (See worklist for details).”

Based on the testimony and notes of the Sector Seattle CFVS Examiner, Night Engineer, and FEACT MI, as well as shipyard repair documents provided by FCA, the USCG MIs only examined the following tanks:

- forward ballast tank;
- #1 port and starboard fuel oil tanks;
- #4 starboard fuel oil tank;
- port and starboard freshwater tanks; and
- port and starboard aft ballast tanks.

Shipyard records provided by FCA indicate approximately 62 square feet of 14mm (0.55 in) steel plate was replaced in the hull.

A large “doubler” plate was found in the forward ballast tank. The Port Engineer testified it was approximately 40 square feet, and the Sector Seattle CFVS Examiner stated he had never seen one so large. It was actually comprised of two plates extending below the waterline, one on the inside and one on the outside of the shell plating on the port side of the tank. After they were removed, three fractures were discovered in the shell plating. The affected area of the hull was cropped and renewed. Shipyard records indicate 27 square feet of 6mm (0.25 in) steel plating was renewed. The Sector Seattle CFVS Examiner also identified many fractured welds in the tank and marked them so they could be repaired. Although some of the work may have been done, it is unknown how much was completed. The tank was refilled only three days after work started in the space. As a result, the attending MIs were unable to reenter or reexamine the tank to confirm what repairs were done.

The FEACT MI examined the aft ballast tanks. According to his testimony and recorded notes, two transverse frames in the port aft ballast tank were significantly corroded and needed to be cropped and renewed. Though these transverse frames were repeatedly referred to as “swash bulkheads” in testimony and repair documentation, vessel construction drawings indicate they were actually transverse frames.

The condition of the transverse frames, and the work necessary to repair them, was not added to the USCG worklist, and no repairs were made in the tank. Documents prepared for FCA by TMPS in preparation for the shipyard work demonstrate the company was aware these repairs were needed “regardless of whether the vessel is enrolled” in ACSA, yet they were not completed. See Figure 14.

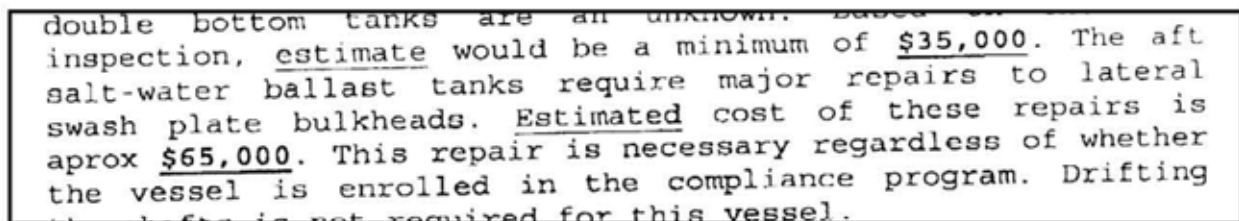

double bottom tanks are an unknown. Based on inspection, estimate would be a minimum of \$35,000. The aft salt-water ballast tanks require major repairs to lateral swash plate bulkheads. Estimated cost of these repairs is aprox \$65,000. This repair is necessary regardless of whether the vessel is enrolled in the compliance program. Drifting

Figure 14: Excerpt from “Yearend Vessel Plan Items for Alternative Compliance Program”

The #1 port and starboard fuel oil tanks also required a variety of repairs to fractures and wastage. Significant repair work done in #1 starboard included the replacement of two frames, the replacement of a corroded swash bulkhead, and an insert in the forward bulkhead. A total of approximately 59 square feet of plating was replaced in the #1 and #4 fuel oil tanks.

In the fresh water tanks, inspectors found multiple fractures, tripped frames, and “broken braces” or gussets. The Sector Seattle CFVS Examiner testified these were repaired. However, based on the shipyard report of work completed, no plating or structural members were replaced or renewed in the fresh water tanks.

The Port Engineer testified fractures were found and repaired in the plating of the outer transom, but stated that none of them had propagated into the hull plating.

The FEACT MI found two transverse bottom frames in the port aft ballast tank that were significantly corroded and needed to be cropped and renewed. Asked if there was anything that prevented him from doing a complete internal structural exam of the aft ballast tanks, the FEACT MI replied, “It’s a maze. I could have missed any portion of it because there’s some areas that you could not go through, very limited access to it. Even the lightning hole is too small. So you just stick your head in there and put your flashlight on to see what’s --- if there’s any significant wastage...”

The FEACT MI testified that when he reported his findings, the Sector Seattle CFVS Examiner stated he would enter the port aft ballast tank to confirm the wastage needed to be repaired. However, the Sector Seattle CFVS Examiner never entered or inspected the space himself.

Thickness measurements, or gaugings, of the hull were taken while the ALASKA RANGER was in drydock. The Sector Seattle CFVS Examiner did not know the original plating thicknesses and testified vessel drawings were unavailable when it was in the shipyard. He required additional gaugings “so I could figure out from those shots what the average is and try to come up with my best assumption of what the thickness of the hull actually would have been as it was built.”

The Sector Seattle CFVS Examiner did not require the stern to be gauged. Though in his testimony to the MBI the FEACTION MI stated there was significant corrosion in the port ballast tank, the Sector Seattle CFVS Examiner testified that he did not require gaugings of the actual stern plating from inside the aft ballast tanks or storerooms because the FEACTION MI found “no excessive corrosion on the inside of the aft bulkhead” of the tanks.

Given the significant wastage found in the aft ballast tanks, and the limited ability of the USCG MI to inspect the condition of the plating from inside the aft ballast tanks, the Sector Seattle CFVS Examiner should have required the stern to be gauged. This could have been done externally through inspection openings in the outer transom or internally at the discretion of the technician taking the gaugings.

When original thicknesses are unknown, the D13 and D17 ACSA Agreement requires the OCMI to make a “reasonable estimate” of the original scantlings. However, Commandant Policy Letter 06-03, “Exemption Letter for Existing Fish Processing Vessels,” states the owner shall be required to present the USCG MI with calculations comparing the existing scantlings to the ABS Rules to demonstrate they are adequate. No written report was provided to the USCG confirming the wastage did not exceed 25% or otherwise demonstrate that the existing condition of the plating and support members satisfied structural standards in the ABS Rules.

The USCG examined watertight and weathertight closures, including the dogs, seals, and coamings, but did not witness testing of any of the watertight doors or hatches to determine if they were watertight. Attending USCG MIs noted discrepancies with the dogs, seals, and operation of several watertight doors and hatches, as identified in the shipyard worklist (inserted below). Covers for the engine room supply air vents were seized open, and covers for the engine room exhaust vents were missing.

Though required by ACSA, the Sector Seattle CFVS Examiner did not require removal and examination of the tailshafts. FCA provided a report of shaft bearing clearance readings taken when the ALASKA RANGER was drydocked in 2005, and the Sector Seattle CFVS Examiner granted an extension until the next drydocking scheduled for 2008.

Since the tailshafts were not removed, neither were the rudders. The Sector Seattle CFVS Examiner “visually inspected them [rudders], meaning I went up and I looked at the -- the seals from the outside. I looked at the rudder posts on the inside. They're very large rudders. Putting my shoulder into it and knocking it one way or the other, neither one of them moved an inch or budged.” They appeared to be satisfactory, and he saw nothing that concerned him. Although he testified the shipyard took readings to measure the wear on the cutless bearings supporting the rudder posts, he never received a report of the findings. The Port Engineer testified that no

examinations or maintenance were performed on the rudders during this drydock period, and the MBI found no evidence that measurements were taken.

No information regarding the examinations conducted by the USCG while the ALASKA RANGER was in the shipyard, or the resulting deficiencies and worklist items, was entered into MISLE until 24 March 2008, the day after the casualty. However, the Sector Seattle CFVS Examiner provided FCA the following worklist (reprinted verbatim) when the ALASKA RANGER left the shipyard:

LIFE SAVEING (sic)

1. Each liferaft embarkation station must have an embarkation ladder. Need one additional ladder.
2. STBD FWD liferaft does not fit into the install bracket.

FIREFIGHTING

2. Provide 2-way communications from each fixed fire pull station and wheelhouse. Communication must have an independent power source. Examples are handheld VHF radios, sound-powered phone or 12V DC house phone.
3. Provide a written plan for activating fixed fire system at the main pull station and at the bottles.
 - Identifies who has authority to activate system
 - Communications with wheelhouse, etc.
 - Signed by Master and Chief Engineer
4. For each fire station, provide appropriate fire hose, nozzle and spanner wrench. All fire station valves in factory space need to be serviced.
5. Conduct operational test of fixed firefighting system from the highest and furthest standpipes.
6. Repair/replace damaged fire station valve and hose box on bow.
7. Both engineroom Halon activation bottles were condemned by Mike's Fire servicing in Dutch Harbor. Replace activation bottles and ensure system is fully operational.
8. Purchase an adequate portable fire pump that is independently powered and meets the requirements of section J (1)(2)(3) of the ACSA agreement. Conduct operational test of portable dewatering pump. Recommend adding an additional pipe with a camlock

fitting to supply vessel's main fire fighting system via portable pump (in case fire main is in operative).

9. Update fire control plan showing the location of all firefighting, safety equipment, location of all fixed firefighting and portable extinguishers and equipment.

10. If vessel is manned with 26 or fewer total crew then show proof of 2 SCBAs, 2 complete bunker gear with 2 spare bottles for each SCBA. If vessel is manned with greater than 26 crew then show proof of 4 SCBAs, 4 complete bunker gear with 2 spare bottles for each SCBA. Need two more complete suits onboard.

11. Ensure all accommodation spaces have appropriate smoke detector installed and operational and not tampered with i.e. sensor is not taped over and system meets or exceeds UL-217 standards

STABILITY

12. Have Naval Architect calculate and provide addendum to stability book identifying all watertight bulkheads, watertight/weather tight doors & openings; all sea valves; and calculations for dewatering sump pumps in the factory area.

- Have Navel (sic) Architect calculate the location of waterline mark. Waterline mark needs to be 12" long and 1" wide, permanently attached to the port/stbd side.

- Repaint waterline after Stability test is completed.

- Have Naval Architect calculate the exact location of the collision bulkhead from the factory deck up to the next deck. "Note" if forward bulkhead is ahead of where the collision bulkhead should be, then the bulkhead at frame #23 will be considered the upper most collision bulkhead. The bulkhead will need to be made watertight and the port/stbd doors leading from the factory to the storage area will need to be Quick acting watertight or weather tight doors. Both doors must be fitted with a sign on both sides reading "Opening authorized for transit only - keep closed at sea".

13. Install factory space high water alarms near each corner of the factory space and the center sumps to sense water accumulation. The sensors will be positioned to alarm at levels greater than 6 inches deep. Time delays (up to 5 sec.) may be incorporated to prevent false alarm due to surge or splash conditions. A visual alarm shall be installed in the factory and at the machinery space control flat. Both visual and audio indicators shall be installed in the pilot house. The visual and audio alarm in the pilot house must be a distinctive indicator at or near the normal piloting station instrument panel.

14. Conduct maintenance on all watertight doors (i.e frozen/painted dogs, rusted/painted knife edges, replace painted gaskets and conduct hose test or chock test on all doors)

15. Develop a preventative maintenance schedule and log for each of the closures listed in the Stability Addendum and administrative controls as list in the ACSA Sec.

F.2.(a)(b)(c).

16. Conduct repairs and maintenance on the following doors and hatches:

- Upper escape hatch in fwd part of galley: Replace seal free up wheel and adjust so hatch will seal correctly.

- Renew aft eng rm escape hatch seal and clean out coaming so hatch will seal correctly.

- Repair/replace hatch to bow thruster space. All dogs frozen and dogging wrench missing.

- Repair/replace large portside eng room escape hatch closing handle does not function and hatch assist spring broken.

- Replace missing seals and dogs to AFT (2) lower stores.

- Free up locking pins for trawl deck hatch.

- Free up P/S engine room intake cover.

- Install covers for P/S engine room exhausts.

- Free up P/S fiddly access doors and ensure they will seal.

17. Factory overboard valves and check valves do not function as designed. Valves stems painted insides of both gate and check valves missing. Conduct maintenance on all valves and ensure both the check valves and valves work as intended.

18. Remove cam lock fitting with 90 deg elbow on No.3 port fuel tank cover in factory and install a cap to seal the tank correctly.

MACHINERY INSPECTION

19. Ensure there are no push-lock fittings being used for fuel and hydraulic oil hoses. All hoses must meet SAE J 1942 or SAE J 1942-1 standards; all fittings must meet SAE-J-1475 standards.

20. Ensure all exhaust piping for main engines and generators is in good condition and all exposed areas are covered with proper lagging.

21. Install flame arrestor bowls beneath all for MDE, Generators and Bow thruster room RACORs.

22. Provide anti-electrical conducting matting for flooring near main switch panel in engine control room.
23. The void where the Hydraulic Hoses for Bow Thruster are located has filled up passed (sic) the bilge alarm. Remove excess hydraulic oil and repair leaking hoses and ensure bilge alarm functions as designed.
24. STBD fiddly has an access hole leading from the inside of the fiddly to the upper most area of the fiddly. Access hole needs to be inserted or a hatch must be installed.
25. Remove welding leads on STBD generator being used as the battery leads.
26. Submit reports to Sector Seattle from this ship yard/haul out (tailshaft reports, propeller, hull audio gauging, stern bearing, hull repairs etc.

TRAINING

27. Provide proof of training for all hose/fire team members. Training must be CG Approved Basic Fire Safety.
28. Provide proof of drill conductor training for 5 people.

MISCELLANEOUS

29. Provide reports from Shipyard for all hull, and internal tank repairs that were completed this Dry-Docking.
30. Provide a repair proposal to MSD Dutch Harbor inspectors and Sector Seattle Fishing Vessel Coordinator that addresses the following areas that will need to be repaired in Dutch Harbor.

FWD BALLAST TANK

- Crop and renew all identified wasted frames P/S sides of upper ballast tank area.
- Crop and renew all identified fractured frames P/S sides of upper and lower ballast tank area.
- Crop and renew all identified wasted and laid over tripping braces P/S sides of upper and lower ballast tank area.

AFT P/S BALLAST TANKS

- Bulkhead separating P/S ballast tank completely detached and lower portion of remaining section wasted. Contact Naval Architect and have them determine if the bulkhead is necessary. Make repairs as necessary.

COMPLETED REPAIRS

- Because of time constraints and the amount of repairs necessary to affect permanent repairs to the FWD Ballast tank all fracture frames were V & welded to affect temporary repairs to allow the vessel to return to Dutch Harbor where permanent repairs were going to be completed. The ship yard sealed (sic) filled the tank before a detailed list could be made. All areas were marked inside the tank with spray paint that needed to be repaired or replaced.

STBD No.1 FUEL TANK

- Frame 8 from OVHD to deck laid over: FM cropped and renewed. Tripping brace renewed.
- Frame 9 from OVHD to deck laid over: FM cropped and renewed. Tripping brace renewed.
- 2nd swash bulkhead from collision bulkhead buckle and laid over from overhead to deck. Cropped and replaced from hull plate in 2 feet from OVHD to deck.
- Inserted fracture located in collision bulkhead located on inner most stiffener.
- Cropped and renewed wasted lower section of 2nd from collision bulkhead.

PORTSIDE HULL REPAIRS

- Removed large doublers 3' by 4' and found (2) smaller doublers under the larger one. Located area inside FWD ballast tank and found a (3) piece doubler. Cropped and renewed

31. The Port and STBD aft Trawl deck doors leading to the engineering passageways will need to be replaced with Quick acting watertight doors (QAWTDs).”

None of the items were assigned a completion date. Though deficiencies identified during dry dock exams are not specifically mentioned, the D13 ACSA Instruction states all deficiencies found during preliminary ACSA examinations were to be identified in a worklist “with specific completion dates for each deficiency.”

The Sector Seattle CFVS Examiner stated that he told the Port Engineer that he expected the engine room fixed fire fighting system to be fully operational prior to the vessel leaving Dutch

Harbor. Similarly, the Sector Seattle CFVS Examiner testified he asked the MSD Unalaska CFVS Examiner to ensure maintenance and repairs on the watertight and weathertight doors and hatches were completed before the vessel departed Dutch Harbor. The corresponding worklist items were 7, 14 and 16. This work was never completed. The Day Engineer testified no hose or chalk testing had been done and the doors and hatches were still in need of maintenance and repairs. According to FCA, the condemned Halon activation bottles for the engine room fixed fire fighting system had not been replaced.

At the time of the casualty, the ALASKA RANGER did not have a valid Certificate of Compliance. On 17 January 2008, after the ALASKA RANGER returned from Japan, the MSD Unalaska CFVS Examiner conducted a voluntary CFVS examination while the vessel was moored in Dutch Harbor, AK, and found the vessel in compliance with applicable laws and regulations. The MSD Unalaska CFVS Examiner then issued a CFVS Decal to the vessel. However, in lieu of a voluntary exam by a USCG CFVS Examiner, vessels enrolled in ACSA must undergo an annual Certificate of Compliance examination by an approved third party examiner. After verifying compliance with 46 CFR Part 28 and 33 CFR Parts 151 and 155, the approved third party examiner issues a Certificate of Compliance and a CFVS Examination Decal.

On 17 January 2008, the MI from MSD Unalaska attended the vessel in Dutch Harbor to examine structural repairs made in the forward ballast tank. USCG MIs normally require non-destructive testing on steel repairs on certificated vessels to confirm the quality of the weld. In this case, the MSD Unalaska MI and the Sector Anchorage CID did not believe they had the authority to require the repair be non-destructively tested because the ALASKA RANGER was not an inspected vessel.

While examining the repairs in the forward ballast tank, the MSD Unalaska MI discovered three additional areas of damage he called “major” structural deficiencies that were not listed for repair by the USCG during the drydock and internal structural exams recently conducted at the shipyard. He issued three work list items calling for the damage to be repaired.

Hull Condition and Structural Repairs

Since all eye witness testimony indicated flooding originated in the stern of the vessel, the condition of the spaces located in the after portion of the hull was of particular interest to MBI. What follows is a summary of material deficiencies for different parts of the hull that are indicative of the vessel’s condition at the time of the sinking.

Aft Ballast Tanks

The port and starboard aft ballast tanks were adjacent to the rudder room and below the ramp room and port and starboard storerooms (Figure 4).

The condition of these tanks at the time of the casualty was unknown. They were not thoroughly inspected by FCA, TMPS, or the USCG while the vessel was in the shipyard. As outlined in Figure 15, these tanks were repaired on a number of occasions and required extensive steel work.

Date	Problem or repair
January 1996	Weld fracture repaired at frame 59 in the starboard aft ballast tank.
September 2004	Free communication noted between the port and starboard tanks.
11 December 2004	Centerline bulkhead repaired, requiring 143 hours of labor.
January 2005	Centerline bulkhead rewelded.
5 October 2005	Centerline bulkhead needs to be rewelded.
17 April 2007	Leaks noted. Cause and exact location cannot be determined from the documents provided to the MBL.
20 August 2007	“Year end Vessel Plan Items for Alternative Compliance Program [ACSA]” indicates tanks require “major repairs to the lateral swash plate bulkheads.” Estimated cost of repairs is \$65,000.
September 2007	Leaks between the port and starboard tanks require repair and listed as line item in shipyard worklist.
3 – 5 November 2007	USCG FEACTION MI identifies cracks, wastage, and detached welds in swash bulkheads
10 November 2007	Sector Seattle CFVS Examiner issues requirement for repairs to the centerline bulkhead.
1 December 2007	FCA’s year-end worklist indicates the required repair work to the centerline bulkhead is not yet completed.
13 February 2008	Centerline bulkhead repair item, noting it is detached and wasted, appears on the worklist forwarded to EBDG for review.
16 March 2008	Repairs to centerline bulkhead are still incomplete and remains on FCA worklist.

Figure 15: Work done to the Aft Ballast Tanks

The centerline bulkhead separating the port and starboard aft ballast tanks was replaced in 2004. However, there was considerable confusion regarding the actual condition of the bulkhead in the months leading up to the casualty. During the shipyard period in 2007 it was reportedly not watertight. The FEACTION MI who entered the aft ballast tanks found it in place. Ultimately, the Sector Seattle Marine Inspector issued a worklist item requiring it be assessed by a naval architect and repaired if deemed necessary.

Ramp and Stern

The stern and ramp were regularly repaired. The transom hull plating was the aft boundary for the storerooms, aft ballast tanks, and ramp room. On the port and starboard sides outboard of the ramp, the transom hull plating was covered by the outer transom, which extended below the water line and protected the shell plating from damage caused by the trawl doors. FCA installed the outer transom on the ALASKA RANGER in order to protect the transom hull plating from damage during fishing operations.

However, no provisions were made to permit internal examinations of the narrow void between the outer transom and the transom hull plating or to protect the steel from corrosion. While

TMPS ensured the inside of each rudder were coated when the vessel was in the drydock and that sacrificial anodes were applied to the hull and internal compartments to prevent corrosion, nothing was done to protect the framing and inaccessible plating of the outer transom or the transom hull plating it protected. Figure 16 shows a list of damage and repairs in way of the transom stern, ramp, and outer transom. Figures 17 and 18 are photographs of the transom stern.

Date	Problems or repair
December 2001	Damage noted on both sides of transom stern and required complete reinforcement. Stern ramp leaking.
12 August 2002	Repairs made to an existing doubler plate.
18 December 2002	Major work performed at shipyard. Doubler plates and coamings added on the ramp.
13 November 2004	Aft vertical corner plates on ramp replaced and weld repaired in lower sections of port and starboard outer transom.
17 October 2005	Damage from trawl doors resulted in fractures in plating on outer transom. Additional doubler plate is installed.
13 November 2005	Major work performed. New doubler plates installed. Repairs to outer transom, port and starboard.
30 November 2007	Major work performed. New doubler plates installed. Repairs to outer transom port and starboard.

Figure 16: Work done to the stern and ramp



Figure 17: Photograph of the stern taken in 2005 showing water draining from outer transom



Figure 18: Photograph of the outer transom.

Storerooms

Before they were converted, which occurred sometime prior to 2004, the port and starboard storerooms were the #5 fuel oil tanks. They were outboard of the ramp room and immediately above the aft ballast tanks. They were directly under the stern rollers and gantry, and various fractures had been found and repaired in these spaces between 2002 and 2005.

Date	Problem or repair
January 2002	#5 tanks leaking.
31 June 2005	Fractures rewelded. Doubler plate installed.
10 October 2005	Year end worklist notes fractures in storerooms must be located and repaired.
5 December 2005	Fractures rewelded and doubler plates installed.
25 December 2005	New hatches starboard installed.

Figure 19: Work done to the store rooms.

Potable Water Tanks

The port and starboard potable water tanks were immediately adjacent to the rudder room. The aft transverse bulkheads of the potable water tanks and their inboard longitudinal bulkheads formed boundaries of the rudder room. Portions of the tailshaft bearing struts and Kort nozzle struts were attached to the bottom plating in way of these tanks. Multiple fractures had been discovered in these tanks since 2002.

Date	Problem or repair
21 November 2002	Portion of plating and frames replaced in both tanks.
15 December 2002	Doubler plate installed. Portion of framing replaced.
16 May 2004	Fracture rewelded. Doubler plate installed.
29 March 2005	12 inch diameter doubler plate installed.
12 April 2005	Doubler plate installed on 29 March 2005 is rewelded.
15 September 2007	FCA worklist item identifies need to inspect & repair both tanks.
31 October 2007	USCG lead MI notes: "Water tanks multiple fractures broken T-braces" and "Both water tanks tripped frames, broken welds, fractures."
30 November 2007	Shipyard work summary states the potable water tanks were repaired.

Figure 20: Work done to potable water tanks



Figure 21: Photograph taken inside of potable water tank showing doubler.

Other areas

Records and testimony indicate many other structural repairs were made throughout the vessel since 2002 and further demonstrate the extent of structural problems it experienced.

Date	Problem or repair
17 February 2002	Fractures discovered in vicinity of pilot house gear locker.
22 May 2002	Previously repaired fractures in vicinity of pilot house gear locker are rewelded again
21 May 2003	Fractures in deck near stern roller are repaired and doubler plate installed.
26 April 2005	Doubler plate rewelded and repaired on bow.
17 June 2005	Framing reattached to shell plating in way of bow and fractures repaired.
19 June 2005	Diver welded and applied soft patch in forepeak tank.

November 2005	Shipyard work summary indicates fractures repaired in forepeak.
28 May 2006	Water leaking into the engine room due to fracture in deck of the factory space. Repairs completed.
1 June 2006	Twelve broken gussets repaired on trawl deck. Doubler plate installed under each gusset.
5 June 2006	Leaking deck is repaired with a doubler plate. Completion of work required removal of fuel from a cofferdam.
6 December 2006	Forepeak tank and chain locker repairs completed to stop leaking between them.
9 April 2007	Leak between the forepeak and chain locker discovered. Corroded weld seam reported and deteriorated portion of bulkhead plating is replaced.
31 October 2007	USCG inspector noted numerous fractures and corroded and damaged braces in forepeak tank.
7 January 2007	Insert completed in shell plating at forepeak tank. Attending USCG MI identifies need for additional structural repairs.
1 May 2007	Fracture in deck forward of the stern roller is repaired.
28 June 2007	Fracture in the vessel's "main frame" rewelded. Doubler plate installed.

Figure 22: List of repairs made in other spaces and portions of the hull

Kort Nozzles

FCA installed Kort nozzles on the ALASKA RANGER in 1991 to improve fuel efficiency. Each Kort nozzle was supported by three struts, two upper struts connecting the top of the nozzle to the hull and one lower strut joining the bottom of the nozzle to the bottom of the shaft strut bearing housing. The shaft strut bearing housing was attached to the hull by two additional struts. The four Kort nozzle upper struts (two port and two starboard) attached to the hull bottom plating directly below the bulkhead at frame 57, which separated the rudder room, potable water tanks, cofferdams, and aft ballast tanks.

Installation

MAN B&W Diesel of Denmark designed and manufactured the Kort nozzles as well as new propeller blades. The design was developed using drawings of the hull and other information provided by the propeller manufacturer and TMPS. It does not appear MAN B&W representatives visited the vessel during the design or installation of the Kort nozzles.

Throughout the design and manufacturing process MAN B&W sent TMPS a number of written requests for additional information, many of them labeled "urgent." These documents asked for a variety of information including specific design and installation details of the propeller strut bearings, the propeller strut connection points and means of reinforcement, and the layout of the propeller hub. Because the ALASKA RANGER was at sea, TMPS personnel visited a similar vessel to gather some of the specific data requested.

To accommodate the static and dynamic forces induced by the Kort nozzles, the installation plan developed by MAN B&W Diesel called for significant modifications to the internal structures of the ALASKA RANGER, including the bulkheads, frames, and hull plating. It included two alternatives for attaching the lower Kort nozzle strut to the propeller strut bear housing, indicating that either design could be used.

On 31 October 1991, MAN B&W submitted the Kort nozzle design to ABS for approval. In a fax dated 6 November 1991, MAN B&W informed TMPS an ABS Certificate could not be obtained for the nozzles and asked them to accept the nozzles without ABS approval. According to MAN B&W, ABS would not review and approve the nozzles because the vessel was not classed.

As shown in Figure 23, an excerpt from the MAN B&W installation plans, the center plates of the upper nozzle struts were to extend through the hull and join directly to a reinforced longitudinal bulkhead, which was to be 24mm thick and extend from frame 56 to frame 58. The existing 12 mm hull plating in way of the nozzle strut attachment was to be removed and replaced with hull plating twice as thick. The two plates inboard and outboard of the center plate of the upper nozzle supports were to be welded to the 24 mm hull plating insert.

This design transferred the weight of the Kort nozzles to the internal framing of the vessel, which is the recommended practice. According to Ship Design and Construction (██████████, Editor, 1980, published by Society of Naval Architects and Marine Engineers), “the inboard ends of shaft struts are usually carried through the shell and attached to special framing arranged to distribute the load from the arms to a sufficiently broad and rigid structure to eliminate any likelihood of local vibration. The hole in the shell plating is closed by heavy plate around the strut arm.”

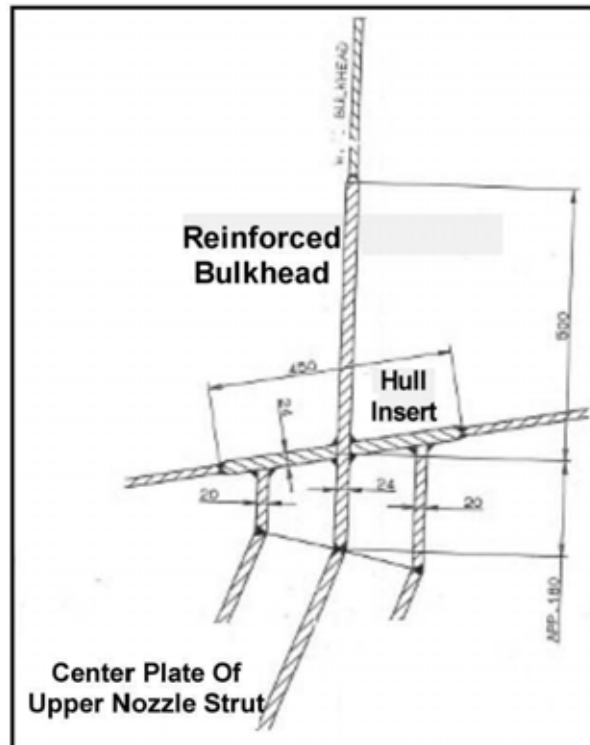

Figure 23: Portion of nozzle manufacturer's installation drawing

The Kort nozzles were supposed to be installed in November 1991 while the ALASKA RANGER was at Yamanishi Ship Building & Iron Works, Ishinomaki City, Japan. While in the shipyard, TMPS discovered the actual structural arrangements of the vessel were different from that assumed during development of the installation plans. Correspondence between a TMPS employee with the vessel in the shipyard and the owner of TMPS states the potable water tanks had “no swash bulkheads or framing” and details of the cofferdams and #4 fuel oil tanks differed from what was shown in the MAN B&W installation plans.

The shipyard developed a separate design for the Kort nozzle installation. An excerpt of the shipyard design is shown in Figure 24. Existing insert areas for the attachment of shaft bearing housing struts are shown in light red, and proposed inserts for the Kort nozzle strut attachments are depicted in orange. Existing inserts surrounding rudder stock housings are colored gray.

The detailed shipyard drawings specified a 24 mm hull plating insert (orange at top and bottom of Figure 24) installed directly aft of the existing insert (shown in red) to which the outboard shaft bearing housing strut were attached. This insert was directly under the longitudinal bulkhead that separated the #4 fuel oil tank (shown in dark green) and the adjacent cofferdam (yellow) as well as the rudder room (light green) and the aft ballast tank (blue). The shipyard drawing indicated that the bottom 1.8 feet of this longitudinal bulkhead was to be replaced with 24 mm thick plate and additional brackets were to be installed to support the bulkhead.

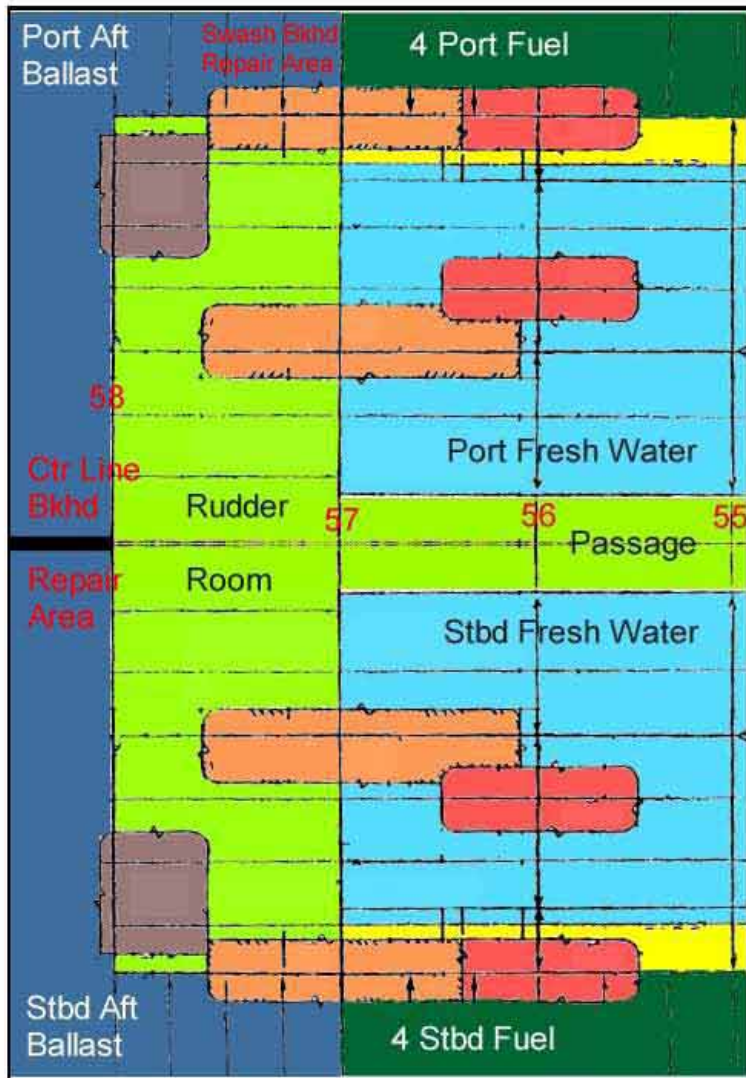

Figure 24: Portion of drawing developed by shipyard for Kort nozzle installation

The shipyard design also called for similar modifications to the hull plating (second orange area from top) and longitudinal frames in way of the inboard Kort nozzle strut attachments. The inboard hull plating insert was not directly aft of the inboard shaft bearing housing strut (second red area from top). The longitudinal frame and hull plating were located in the potable water tanks (light blue) and rudder room (light green).

However, the Kort nozzles were not installed in Japan. Rather, the ALASKA RANGER returned to a shipyard in Seattle to have the work done. Neither the manufacturer's nor the Japanese shipyard's design were followed in the final installation.

The owner of TMPS testified there were no perforations made to the hull when the Kort nozzles were installed. Instead of inserting thicker plating and joining the center plate of the nozzle strut directly to the longitudinal bulkhead inside the hull, the Kort nozzles were simply attached to doubler plates that were welded to the shell plating outside the hull to provide local support. He

indicated that doubler plates were also located in the hull inside of the cofferdams, but no doubler plates were installed in the rudder room, #4 fuel oil tank, or potable water tanks. If so, the Kort nozzle strut landing areas located in way of the rudder room, aft ballast tanks, #4 fuel oil tanks, and potable water tanks were not reinforced. The load and stresses from the Kort nozzles were not properly distributed, and the struts experienced significant vibrations for which they were not properly reinforced.

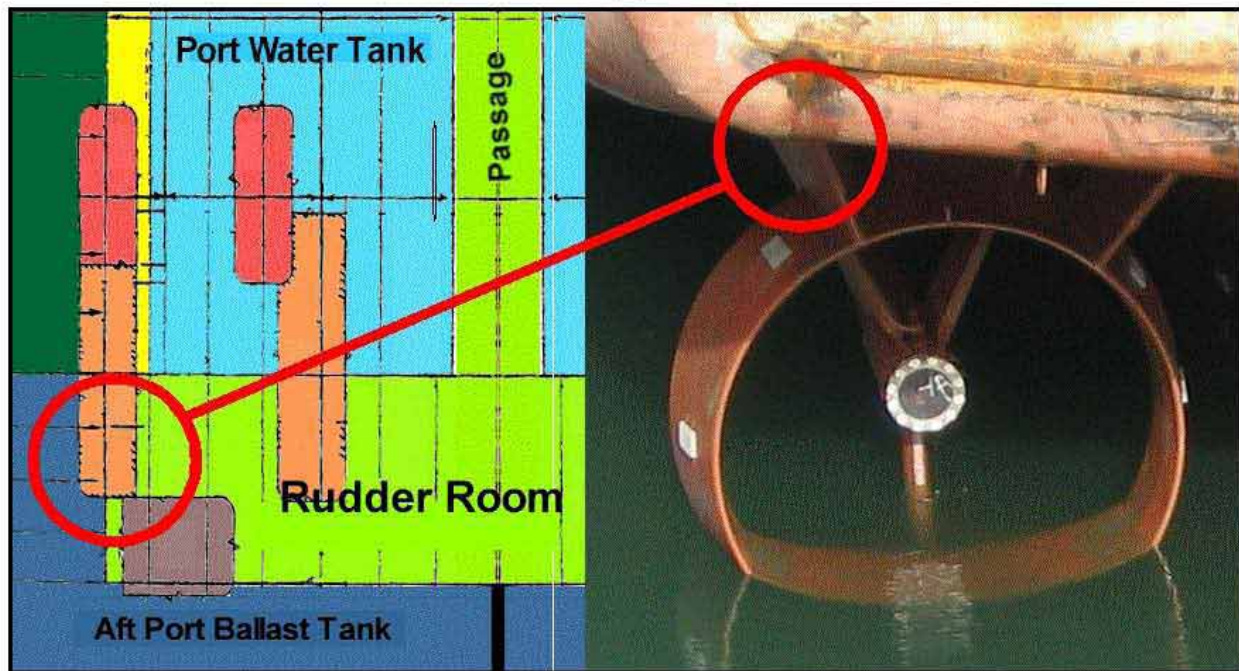

Figure 25: Upper right red circle: Location of Kort nozzle strut fractures

Lower left red circle: Location of corroded frames in port aft ballast tank.

A document labeled “Year End Repair Alaska RANGER 1992, Specification for Nozzle Installation” mentions modifications made to the Kort nozzle struts in 1992, approximately one year after the original installation.

The owner of TMPS confirmed that as initially installed, the Kort nozzles developed cracks where the struts connected to the nozzles and explained the modifications to the Kort nozzle struts were needed because the struts were “not stiff enough.” He believed the struts vibrated excessively because the natural frequency of the Kort nozzle was too close to the natural frequency of the hull. In his opinion, the nozzle struts needed to be stiffer in order to drive the resonance frequency of the Kort nozzle outside the oscillating frequency of the hull.

Documentation describing the modifications to the Kort nozzles shows the changes included the addition of a one inch thick plate fitted between the existing “nozzle supports” on the shell plate and the center plate of the nozzle support struts. Additionally, the Kort nozzle struts were streamlined with foils in accordance with a sectional view provided by MAN B&W in the original installation plans.

The documentation describing the modifications to the Kort nozzles explicitly refers to TMPS drawings numbers 5014 - 1 through 3. Though the MBI requested copies of these TMPS drawings, FCA and TMPS were unable to produce them.

Installation drawings and photographs indicate a portion of the outboard strut for the port Kort nozzle would have been attached to the hull in the vicinity of the two corroded transverse frames documented by the TMPS Port Engineer and FCA Operations Manager in August 2007 and found by the USCG MI in the port aft ballast tank in October 2007. See figure 25.

Repairs

As outlined in Figure 26, the port Kort nozzle struts had various fractures in recent years. Though the exact causes of these structural failures are unknown, they may have resulted from excessive vibrations, improper weld procedures, or fatigue resulting from an inadequate design or improper installation of the Kort nozzles. Neither FCA nor TMPS requested EBDG, or any other engineering firm, to perform a structural analysis to determine the cause of the recurring fractures.

The owner of TMPS testified, “We had some fractures here and there at some point in time. That was fixed, of course. Not in the hull, but on the struts, on the Kort nozzle. That was repaired. And I think even last time when we were in drydock in 2005 we had some fractures at the Kort nozzles where those support legs comes in. That was all gouged out and rewelded. And I think [TMPS Port Engineer] told me about another fracture we had this time in Japan in 2007.”

Date	Problem or repair
18 November 2003	20 inch fracture at bottom of the port outboard strut repaired by divers.
12 November 2005	Unspecified work being done to top of port inboard strut.
18 June 2007	Fracture found at bottom of lower port Kort nozzle strut in way of connection to shaft strut bearing housing.

Figure 26: List of repairs made to the Kort nozzles

Despite the frequency of the fractures, aside from the diving contractor’s invoices, no documents were provided to the MBI documenting fracture repairs related to the nozzles. Without further information, the MBI was unable to evaluate the welding procedures used by the repair facilities or the type or extent of nondestructive testing used to verify the quality of the repairs. The following excerpt from NVIC 7-68 emphasizes the impact weld deficiencies may have on a vessel:

(1) Particular attention is called to weld deficiencies which can occur if correct procedures are not followed. These weld deficiencies can and do lend to cracking of the main hull girder of the vessel and are about the most effective crack initiators known. The destructive potential of the deficiencies often lies dormant for protracted periods while awaiting the necessary conditions of temperature and/or service stress magnitude to trigger a crack which instantaneously propagates into a serious hull failure. Such failures can occur under fairly moderate stresses, arising from sea action or from cargo distribution alone, on a cold winter day.

Figure 27: Excerpt from page 29 of Enclosure 1 to NVIC 7-68



Figure 28: Photograph of worker repairing the inboard port Kort nozzle strut

In Figure 28, a welder can be seen welding on the port nozzle inboard strut near the hull of the vessel. No information regarding the procedures for these types of repairs was obtained during the investigation. It is unknown whether a crack on the outer fairing or shell of the nozzle would

automatically initiate an inspection of the condition of the internal structural area by FCA, TMPS, or a member of the ship's crew.

Management of Vessel Repairs and Maintenance

Role of Trans Marine Propulsion Services (TMPS)

TMPS was involved in the conversion of the RANGER and provided engineering support to FCA ever since. At the time of the casualty, FCA relied solely on TMPS to provide engineering services and coordinate maintenance and repairs for the entire FCA fleet, including the ALASKA RANGER.

This service was managed almost exclusively by a single TMPS employee who effectively served as the port engineer for FCA. FCA's Operation Manager stated in testimony, "We rely totally on [TMPS Port Engineer], as far as anything other than the ordinary maintenance that the chief engineers might do. I guess you could say that [TMPS Port Engineer] is our port engineer, with all that implies, even though he is employed by Trans Marine." He also testified that this relationship with TMPS had existed for approximately 20 years.

The TMPS Port Engineer responsible for the ALASKA RANGER and all the FCA vessels at the time of the casualty testified he had served in that capacity for 10 or 11 years and had previously worked for an engine manufacturer for 27 years. He stated his role and involvement was directly associated with vessel repairs and maintenance. Further, he said it was not limited to engine or main propulsion work, but encompassed all areas of the vessel and all types of repairs. He regularly approved repair requisitions, identified vendors and contractors to perform the work, created cost estimates, developed shipyard and repair worklists, and identified needed spare parts.

The TMPS company website indicated the Port Engineer had been with TMPS for over 15 years and was "currently responsible for the technical management of a fleet of fishing vessels working out of Dutch Harbor, Alaska. Assisted by a superior technical staff, [TMPS Port Engineer] offers combined knowledge of all vessel machinery. This, in part, increases the service life of the machinery and makes maintenance more cost effective. (emphasis added)" It did not state the Port Engineer had the technical capabilities or resources necessary to manage other aspects of vessel maintenance outside the machinery, including structural failure analyses, hull and tank structural examinations and surveys, and steel repairs.

This was underscored by the testimony of the owner of TMPS who said they did not evaluate structural repairs or conduct stability assessments: "We will not go into areas we don't know or we don't have any knowledge about really. ... And we don't, we don't go into these areas because that's not our expertise."

Despite their stated lack of expertise outside machinery, TMPS did subcontract a substantial amount of work to various shipyards and vendors for the maintenance and repair of FCA vessels. On the ALASKA RANGER, TMPS had recently subcontracted Marine Electrical to perform electrical installations and maintenance. Previous electrical work had been subcontracted by TMPS to two other companies, Eltech and Sea Technology. Alpha Welding and Boat Repair

had been used for steel repairs in Dutch Harbor. Bird-Johnson, and later MCR Engineering, had refurbished and serviced the controllable pitch propeller system. Lastly, EBDG conducted inclining experiments and stability analyses.

As outlined in previous sections of this report, significant structural repairs and maintenance had been completed aboard the ALASKA RANGER. Yet, the MBI found no evidence that TMPS consulted EBDG, or any other naval architecture firm, for technical support for these types of repairs. In addition, none of the records provided by EBDG, FCA, or TMPS demonstrate EBDG provided technical support to FCA or TMPS leading up to and during ALASKA RANGER's 2007 shipyard period in Japan. In February 2008, months after the vessel left the shipyard, EBDG did provide a work proposal to FCA, care of the TMPS Port Engineer, to address worklist items issued by the USCG after the dry dock and internal structural examinations.

Performance of TMPS and Fishing Company of Alaska

The Port Engineer and owner of TMPS were routinely made aware and had knowledge of conditions and circumstances aboard the ALASKA RANGER. The Port Engineer communicated with the vessel crew, handled repairs and technical issues daily, and reviewed and approved hundreds of requisitions and purchase orders. TMPS would help prepare the vessels for the fishing seasons, develop repair budgets, and communicate concerns to FCA. The worklist and estimates were submitted to the FCA Operations Manager for approval.

To make repairs to the hull, TMPS and FCA typically had doubler plates installed or fractures rewelded. Though doubler plates can be an effective temporary repair, they are rarely accepted as permanent repair on inspected or classed vessels because they do not ensure continuity of strength and create discontinuities that may induce, rather than prevent, a structural failure. Properly welding fractures can restore and preserve the strength of the structures, but regular and recurring fractures can be symptoms of design flaws and excessive stresses and should be investigated by a competent entity.

In accordance with "good marine practice," the repair work previously described in the "Hull Condition and Repairs" section of this report should have been analyzed and reviewed in a broader effort to more fully understand the risks and potential dangers that may have been developing and to determine appropriate corrective and preventative actions.

Though there is no evidence the structural condition of the hull was evaluated by a marine surveyor, naval architect, or similarly qualified individual, TMPS was aware of all deficiencies reported by the crew and had the most comprehensive knowledge of the problems aboard the vessel. The MBI found no evidence that TMPS made any effort to evaluate the local or global hull stresses in an attempt to assess the adequacy of the structural design, including the Kort nozzle strut connections, which experienced fractures.

Given the reoccurrence and frequency of fractures in way of the Kort nozzles and other structural members in the aft portion of the hull, TMPS should have sought the counsel of competent structural engineers. Additional investigation and research should have been conducted to determine the causal factors of the failures and appropriate corrective measures.

The TMPS Port Engineer and the owner of TMPS testified FCA provided adequate financial resources to make necessary repairs. In practice, however, FCA and TMPS deferred repairs. At least two months before the ALASKA RANGER went into the shipyard in 2007, TMPS prepared a document that was signed by the FCA Operations Manager and specified numerous structural repairs needed on vessels in the FCA fleet. The extent of the list suggests several years of inattention and neglect.

According to the 20 August 2007 document, the \$145,000 in structural repairs needed on the ALASKA RANGER included structural work in the forepeak tank and double bottom tanks. In addition, the aft ballast tanks would “require major repairs to lateral swash plate bulkheads.” However, the Port Engineer and FCA Operations Manager both testified they were unaware that the ALASKA RANGER needed any major repairs when it went to the shipyard.

After the vessel arrived at the shipyard, representatives for FCA or TMPS never entered the aft ballast tanks to assess their condition and no work was completed inside them. Similarly, neither TMPS nor FCA conducted a complete and thorough inspection of all spaces on the ALASKA RANGER to identify and repair fractures, corrosion and other defects.

If safety was a primary concern of FCA and TMPS, the extensive steel work requirements listed in the 20 August 2007 document would have never been allowed to accumulate and potentially affect the vessel’s seaworthiness. FCA and TMPS would have ensured the work was completed during the shipyard. Based on the work completed in the shipyard in 2007, their priorities were focused on production items related to fish catching, processing, freezing and storage.

Controllable Pitch Propeller System

Design

The ALASKA RANGER was fitted with two controllable pitch propellers (CPP), which have blades that rotate about their radial axis to change pitch and the vessel’s speed. When the pitch is positive, forward thrust is generated. When the pitch is negative, reverse thrust is generated.

As the vessel moves ahead or astern, the CPP’s hydraulic system must overcome the pressure of the water against the face of the blades in order to move and/or hold the blade at a specified pitch. The hydraulic pumps that generated the hydraulic pressure necessary to move and hold the blades on the ALASKA RANGER were driven by electrical motors tied to the ship’s electrical distribution system.

When hydraulic pressure is lost, forces created by the rotating propeller hub act to change the pitch of the blades. Due to factors such as performance, balance and vibration, the blades are not flat, but shaped, and are designed to be most efficient when going ahead. This shape, in combination with other factors such as the operational condition of the ship (e.g. is it going ahead or astern, is it in a turn, are both shafts turning, etc.), affect how the pitch of the blades will change if hydraulic pressure is lost.

On the ALASKA RANGER, the pitch became negative and the blades generated astern thrust when the propeller shafts were turning without CPP hydraulic pressure (e.g. if electricity was lost

to the hydraulic pump motors). This occurred on at least one occasion in May 1996, when the ALASKA RANGER lost electrical power while at the dock with the main engines running. With the loss of electricity, the CPP system went from zero pitch to negative pitch, and the vessel went astern and collided with the ALASKA WARRIOR, which was moored just aft.

It happened again during the sinking of the ALASKA RANGER. As the flooding progressed in the engine room, the hydraulic pump motors and their associated controllers were submerged. This resulted in their failure and the subsequent loss of hydraulic pressure to the CPP system. With the main diesel engines continuing to turn the propeller shafts, the ALASKA RANGER went astern, significantly hampering attempts to board the liferafts.

The CPP system installed on the ALASKA RANGER was fitted with a “Take-Home” feature designed to permit the setting and maintenance of positive pitch in the event the hydraulic control system was lost. While this feature utilized a mechanical lock, it required the application of hydraulic pressure from an auxiliary pump to move the blades to the desired pitch before locking the blades in place. This could only be done in the engine room.

Remote Main Engine Emergency Shutdowns

Another means to prevent the astern motion caused by loss of CPP hydraulic pressure was to shut the main engines down. On the ALASKA RANGER, the main engines could be shut down from the engine room and from the pilot house console. (The pilot house console was not outfitted to start the main engines.) While the pilot house console had these remote main engine emergency shutdown switches, the normal practice on board was for the engine room personnel to stop the engines.

The pilot house remote main engine emergency shutdowns were serviced and tested in January of 2008. During the testing, one remote emergency shutdown did not function properly, but was repaired by the Automation Technician. The tests were observed by the previous Captain and the Night Engineer, but the Captain and Mate were not present.

Despite having participated in the testing of the remote emergency shutdowns, the Night Engineer testified the main engines could not be stopped from the pilot house and only personnel in the engine room could shut them down. The Day Engineer also testified that personnel in the pilot house did not have the capability to shut the main engines down.

Based on testimony, the Captain was surprised when the vessel went astern just prior to the vessel sinking. At that time, it was probably no longer safe to enter the engine room, and the only way to stop the engines was by using the remote main engine emergency shutdowns. However, there was no warning notice or instruction alerting officers or crew members to the possibility that the vessel might go astern, nor were there written procedures or instructions on handling the situation.

Rudder

Installation

The ALASKA RANGER was equipped with two semi-balanced spade rudders. Each rudder blade was approximately nine feet high and is estimated to have weighed about 7,250 lbs.

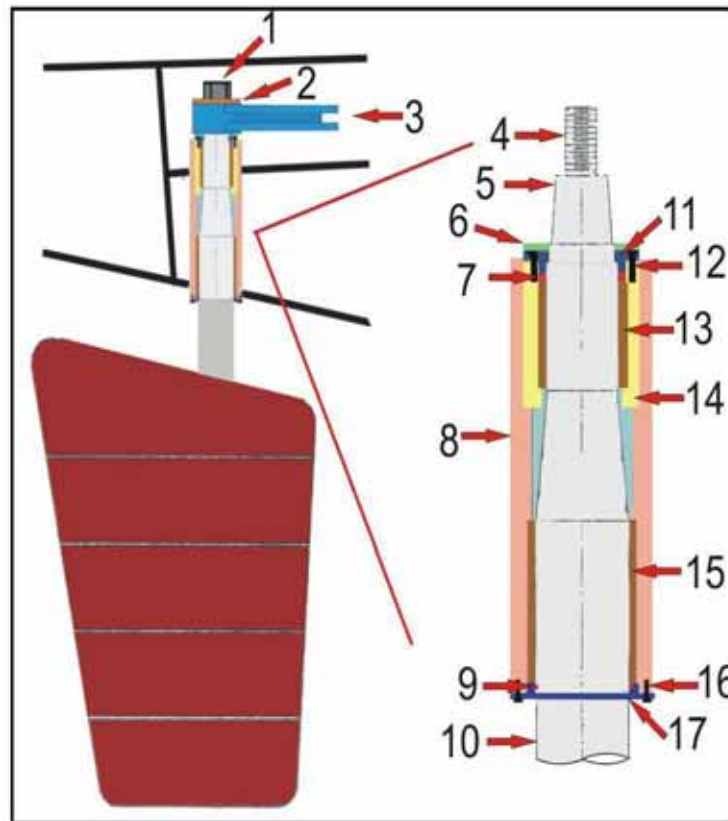

Figure 29: Rudder configuration

- | | |
|--------------------------|---------------------------|
| 1: Rudder Nut | 10: Rudder Stock |
| 2: Washer | 11: Jump Preventer |
| 3: Steel Tiller Assembly | 12: Machine screws |
| 4: Threaded End | 13: Upper Bearing Area |
| 5: Keyed Taper Area | 14: Bearing Retainer |
| 6: Thrust Bearing Plate | 15: Lower Bearing Area |
| 7: Upper O-ring seal | 16: Machine screws |
| 8: Rudder stock housing | 17: Lipped Retainer Plate |
| 9: Lower O-ring seal | |

The rudder stock was 15.5 feet long and 12 inches in diameter. The upper end of the stock tapered from 12 inches to 9.25 inches. The rudder was fitted to the vessel through the rudder stock housing. The rudder stock housing (8) was strengthened with transverse and longitudinal frames to withstand the static and dynamic loads created by the rudder.

The rudder stock housing (8) was about 45 inches high and contained two bearing areas, an upper bearing (13) and a lower bearing (15). The upper bearing was approximately 13 inches long and the lower bearing was approximately 17 ½ inches. The upper bearing was pressed into a bearing retainer (14) that was pressed into the stock housing. The lower bearing was pressed directly into the rudder stock housing. Both bearings contained grooves which allow the distribution of grease from external fittings.

A lipped retainer plate (17) was bolted into the lower rudder stock housing and compressed the lower O-ring seal (9) located at the circular edge of the bearing surface. Compression of the O-ring by machine screws (16) acting on the lipped retainer plate (17) moved it inward and sealed the rudder stock (10).

At the top bearing, a similar arrangement was used. A plate, called a jump preventer (11), was bolted into the bearing retainer (14) and also served to compress the upper O-ring (7) that sealed against the edge of the upper bearing and rudder stock. Above the jump preventer was the thrust bearing plate (6).

Above the thrust bearing plate, the rudder stock had a keyed taper area (5) and threaded end (4). Together, the taper and the threaded section were 7 inches long. The steel tiller assembly (3) was installed on top of the thrust bearing plate (6) and had an internal taper and keyway.

A key fit into the keyways of the tapered area and the steel tiller assembly and ensured the rudders were aligned properly with the steel tiller. Installation of the steel tiller assembly required an interference fit against the shaft with narrow tolerances. To complete the interference fit, the steel tiller assembly is heated to expand the steel, while the tapered area is cooled to shrink it. As the parts reach ambient temperature, the steel tiller assembly contracts and the tapered area expands, and the friction created by the “interference” holds the tiller assembly in place.

The threaded section of the rudder stock accepted a 4 inch diameter, 4 threads per inch, national coarse rudder nut (1). A washer (2) was placed between the rudder arm and the nut. A steel keeper plate, not shown in Figure 29, was fitted on top of the steel nut and served as a locking device. It was welded to the top of the rudder stock and to both sides of the nut, and locked the entire assembly in place to prevent the nut from coming loose.

Each steel tiller assembly was connected to a hydraulic steering system. A crossbar, or “jockey bar”, connected the two steel tiller assemblies. The cross bar ensured the rudders were aligned, and enabled the vessel to be steered with only one hydraulic steering system in operation.



Figure 30: Steel Tiller Assembly showing hydraulic steering system connection and cross connect (from M/V DEFENDER)

Possible Loss of Rudder

Though the Night Engineer initially reported to the Mate that the rudder had fallen off, the MBI does not believe a rudder was lost. In order for the vessel to lose a rudder, the steel keeper plate and its welds to the rudder stock and nut would have had to have failed. Further, some type of counter torsional force would have had to have developed to cause the nut to loosen. The keeper plate would then have to rise above any broken weld beads to allow the nut to back off, if it was still attached to the nut surfaces. Finally, the tiller assembly would have to lose its interference fit, and only then would the rudder have fallen provided the nut was completely unthreaded.

These actions would take a considerable amount of time to occur. The failure of the keeper plate and the loosening of the nut would have been readily apparent to someone visually checking the space. Additionally, the loosening of the tiller assembly would result in a reduction in the range of rudder motion, alerting the pilot house to a possible problem with the gear. Finally, if the tiller came loose and moved against a loosening key and keyway, it would create abnormal sounds in the rudder room. The vessel's engineers, who should have been in the rudder room to grease the bearings and inspect the equipment during normal machinery space rounds, should have seen or heard one or more of these telltale signals alerting them to the problem.

The owner of TMPS testified that on one occasion in 1990 a tiller assembly did loosen up on a rudder stock and required repairs. He stated the shrink fit failed and the tiller arm came loose, but that the nut did not loosen or come off.

Vessel Stability

Stability Standards

On August 1, 1986, the Commandant published Navigation and Vessel Inspection Circular (NVIC) 5-86, Voluntary Standards for U.S. Uninspected Commercial Fishing Vessel. This NVIC consolidated the technical aspects of fishing vessel design, construction and equipment from NVICs 5-85 through 9-85 into one policy document that also incorporated input and feedback from fishing industry representatives and other interested parties.

Included in the NVIC are stability standards that are either recommended or presented for consideration during the design, construction and operation of fishing vessels. Areas covered by these standards, relevant to vessel stability, include intact and damaged stability criteria, inclining experiments and deadweight surveys, recommended loading conditions, free surface effects, environmental factors, and operating information for masters.

The intact criteria in the NVIC are a compilation of various standards covering different aspects of intact stability. Of particular interest with regards to the ALASKA RANGER are the Torremolinos Righting Energy Criteria, the International Maritime Organization Severe Wind & Roll Criteria, treatment of lifting weights and icing.

The damaged stability criteria recommended in the NVIC include the extent of damage to be modeled in evaluating a vessel's damaged stability and the criteria for survival. The survival criteria include range of residual stability after damage, angle of heel after damage, submergence of downflooding points and righting arm length.

On September 14, 1991, the Commandant published the commercial fishing industry vessel regulations. Codified in 46 CFR Part 28, these regulations implemented the provisions of the Commercial Fishing Industry Safety Act of 1988 for U.S. documented or state numbered uninspected fishing industry vessels .

Subpart E of 46 CFR Part 28 contains the stability requirements for commercial fishing industry vessels. It is applicable to each commercial fishing industry vessel greater than 79 feet in length that does not require a load line and either had its keel laid or underwent a substantial alteration after September 15, 1991.

With few exceptions, 46 CFR Part 28 incorporated the intact and damaged stability standards of NVIC 5-86. For vessels falling under the applicability of Subpart E, the voluntary stability standards in the NVIC became mandatory.

However, within the unintentional flooding requirements of 46 CFR Part 28, an exclusion was incorporated providing a means for vessels to opt out of the damage stability requirements if they obtained and maintained a load line certificate. The justification in the preamble of the final rule

explains that the majority of stability related casualties are attributed to watertight integrity problems. The preamble goes on to explain that a hull examination for the purpose of determining a vessel's material condition, as is conducted during annual load line examinations, would alleviate the problems. As a result, vessels subject to the unintentional flooding requirements can be exempted from those requirements provided they obtain and maintain a valid load line certificate.

Stability Tests

When it was converted to a fishing vessel, the ALASKA RANGER was not required to comply with stability criteria contained in 46 CFR Part 28 Subpart E. However, to obtain the load line assignment that was required when it was converted to a fish processing vessel in 1990, FCA was required to provide calculations that demonstrated the ALASKA RANGER had adequate stability. The ALASKA RANGER underwent a stability test on 20 October 1990 to establish lightship criteria and EBDG performed an intact stability analysis and applied the following criteria from NVIC 5-86 and 46 CFR Subchapter S:

- Torremolinos Righting Energy Criteria
- International Maritime Organization Severe Wind & Roll Criteria
- Lifting Criteria
- Icing Loads
- Towing Criteria

Though the initial calculations were approved by ABS, the MSC found errors in the submittal in June 1991. A subsequent stability study determined that fixed ballast was necessary. After the fixed ballast was installed in 1991, the stability review was completed and the vessel received its load line in 1992.

On June 10, 2005, another stability test was conducted on the ALASKA RANGER in Dutch Harbor, AK. This test was likely performed to satisfy the ACSA enrollment prerequisite, which requires that each vessel must have undergone a stability test within the last five years. The test, comprised of an inclining experiment, freeboard readings and a lightweight survey, was performed by EBDG. According to the Stability Test Report, dated September 25, 2005, the test was conducted in accordance with ASTM standard F 1321-92, Standard Guide to Conducting a Stability Test.

However, the test did not strictly adhere to the ASTM standard, EBDG calculated the vessel's "Operational Lightship" values instead of traditional lightship values. This qualification of the lightship values acknowledged the vessel was in an operational state at the time of the test resulting in displacement and center of gravity values less precise than would normally have resulted from tests conducted per the standard. These operational values were then used to evaluate the vessel's stability in order to provide stability guidance to the Master.

The Operational Lightship values were:

Displacement:	1,728.81 Long Tons (LT)
Longitudinal Center of Gravity:	100.63 ft aft of frame 0
Vertical Center of Gravity (VCG):	18.35 ft above the baseline

Stability Test Analysis

The MBI asked the USCG Marine Safety Center (MSC) to conduct an independent review of EBDG's 2005 stability test report. During the evaluation several deviations from the ASTM standard were identified. These deviations likely degraded the test's accuracy and the precision of the resulting lightship characteristics.

Without retesting the vessel, it is difficult to independently confirm the resulting "Operational Lightship" values were conservative approximations of the ALASKA RANGER's lightship characteristics. There are simply too many variables to make that determination now.

Despite the discrepancies, the lightship data calculated by EBDG and used throughout their stability calculations provided the best information available regarding the ALASKA RANGER's lightship characteristics. As such, the values determined by EBDG were used by the MSC in the vessel stability analysis performed at the request of the MBI.

Vessel Stability

Using the Operational Lightship values from the stability test performed in 2005, EBDG performed an updated analysis of the vessel's stability and applied the same criteria. The results of the analysis were used to revise the Trim & Stability Booklet, which was dated 11 January 2006 and provided to the vessel operator. EBDG did not evaluate the stability of the ALASKA RANGER in a damaged condition, and there was no requirement to do so.

Following the guidance in NVIC 5-86, EBDG's analysis evaluated the stability against sample loading conditions representative of the ALASKA RANGER's typical operating conditions. These conditions, contained in the Trim & Stability and Stability Supporting Data Booklets, include departure, fishing and return to port conditions. In each condition, with one exception, the vessel passed all stability criteria with comfortable margins. The one exception concerned the vessel's condition when returning to port with 10% or less fuel and consumables aboard with a full load of fish. In this condition the vessel did not pass the metacentric height requirement of the Torremolinos Righting Energy Criteria. This was addressed by providing guidance to the Master in the Trim & Stability Booklet to ensure the vessel returned to port with a minimum of 20% fuel.

Vessel Stability Analysis

The stability calculations and Trim & Stability Booklet completed by EBDG in 2006 were not submitted to the USCG, ABS, or any other qualified organization for review or approval, and there was no requirement to do so. However, at the request of the MBI, the MSC conducted an

independent verification of EBDG's calculations. The verification utilized the computer model created by EBDG for use with Creative Systems' General HydroStatics stability analysis software. The model was further refined by the MSC to include the compartmentation necessary for a damaged stability analysis.

The guidance in the Trim and Stability Booklet was based on maximum vertical center of gravity (VCG) curves. These curves showed the maximum allowable VCG over a range of displacements. In order to verify EBDG's calculations, the MSC independently generated maximum VCG curves for the intact stability criteria applied by EBDG and determined the curves were accurate.

In doing so, the MSC determined the limiting criterion was an intact righting energy requirement in the Torremolinos Criteria. Specifically, the minimum righting energy requirement between 30 degrees of heel and submergence of the lowest downflooding point was the limiting factor. Because the lowest downflooding points were the engine room intake vents, located less than 4 feet off the trawl deck and aft of amidships, the allowable VCG that passed this criterion was reduced in any condition with aft trim.

Although, the ALASKA RANGER was not required to meet these criteria, at the request of the MBI the MSC also evaluated the vessel's ability to pass the unintentional flooding, or damaged, stability criteria in 46 CFR 28.580.

In its evaluation of the unintentional flooding criteria, the MSC used the same loading conditions used by EBDG in the creation of the Trim & Stability Booklet and assumed all watertight bulkheads and doors were installed and fully effective. The results indicated the ALASKA RANGER failed to pass the criteria in every loading condition due to the large floodable volumes in the factory and engine room. The associated free surface effects with these compartments were very large raising the vessel's vertical center of gravity beyond the limits of its stability.

Despite the inability of the ALASKA RANGER to pass the unintentional flooding criteria, it is important to note the analysis indicated the vessel would likely not have sunk or capsized as a result of flooding the rudder room alone. Even if the vessel were fully loaded, the flooding of this space would not have resulted in the vessel's loss if the flooding was contained to this compartment alone.

Stability Guidance

Stability guidance for the Captain was compiled in the Trim & Stability Booklet and the Stability Supporting Data Booklet. Information for typical operations was covered with sample loading condition summaries and stability operating instructions. For occasions when the vessel operated in atypical conditions, stability worksheets and associated instructions were provided to ensure the vessel operated within the limits of the applied stability criteria. These booklets were also augmented with a computer based system that performed the calculations for the Captain.

During its verification of EBDG's stability calculations, the MSC reviewed the Trim & Stability Booklet and the Stability Supporting Data Booklet and determined they satisfied the guidance in NVIC 5-86 and 46 CFR 28.530 for content and presentation of stability information for use by the Captain.

Pre-casualty Stability

From testimony it was determined the Full Load Departure condition in the Trim & Stability Booklet was largely representative of the ALASKA RANGER's condition at the time of the sinking. The MSC, using additional testimony and evidence, further refined the loading condition to arrive at an even closer approximation of the vessel's condition. Such refinements included fish on board, tank loading, and fishing gear composition.

The amount of the fish on board was determined from the daily tally sheet dated 21 March 2008. This sheet showed the fish on board when the ALASKA RANGER returned to port on 21 March to change fishing gear prior to departing on its last voyage. Testimony revealed the catch was not offloaded and was stored in the #1 and #2 Freezer Holds.

Similarly, the tally sheet indicated the amount of fuel on board at 2400 on 21 March. In addition, testimony provided an approximation of the amount that would have been consumed between the recording of the tally sheet and the time of the casualty. Taken collectively, a conservative estimate of the fuel on board was made. The condition of the remaining tanks was also determined through crew member testimony.

The Trim & Stability and Stability Supporting Data Booklets contained information regarding the weights and locations of fishing gear. However, what was actually carried on board was always unique to the species being fished. This common practice was reflected in testimony that revealed the gear was changed out during the short port call just prior to ALASKA RANGER's last voyage. While the exact composition of gear is unknown, an estimate was made by interviewing a past master familiar with the fishing gear required and the ALASKA RANGER.

Through testimony other elements of the pre-casualty loading condition were determined and incorporated. These included extra fish storage bags, the condition of the bilges, icing, and free communication between the aft port and starboard ballast tanks due to an allegedly compromised centerline bulkhead.

From this information, the MSC determined the most likely loading condition at the time of the casualty. In this pre-casualty condition, the ALASKA RANGER was trimmed 3.3 feet by the stern and listing 1.85 degrees to starboard. In this aspect not only was the rudder room completely submerged below the waterline, but the waterline was about 1 foot above the main deck at the transom.

The Pre-Casualty loading condition was estimated to be:

Displacement:	2,570.80 LT
Longitudinal Center of Gravity:	100.35 ft aft frame 0
Vertical Center of Gravity:	17.04 ft above the baseline

Prior to conducting a flooding and sinking analysis, the MSC evaluated the ALASKA RANGER's stability in the pre-casualty condition against the same intact stability criteria discussed earlier in this report. The vessel passed with almost 2 feet of margin for the vertical center of gravity.

Review of Key Events in the Flooding and Sinking

The crew first discovered the flooding when the rudder room bilge alarm sounded. The alarm was acknowledged by the engineer on watch who, upon investigating the alarm, said he immediately saw water when he looked into the rudder room. He described the water as rising rapidly and flowing towards him. He also recalled seeing a telltale rag, which had been tied to the steering linkage between the two rudders, hanging in its usual position. After he closed and dogged the door, he started the bilge pumps, taking suction from the rudder, hydraulics and engine rooms, prior to leaving the engineering spaces.

Testimony indicated that just minutes after the rudder room bilge alarm sounded water was discovered flooding the ramp room directly above the rudder room. The water was flowing over the port and starboard watertight door coamings and into the adjacent spaces. The exact source was never determined.

Despite observing flooding in the rudder and ramp rooms, none of the crew recalled or mentioned hearing loud noises such as cracking, splitting, hammering or knocking. Unusual vibrations, shudders or impacts were not reported either. Finally, no steering or propulsion problems were observed prior to the discovery of flooding.

The Emergency Squad responded by positioning dewatering equipment in the vicinity of the workshop on the starboard side of the factory deck. However, dewatering of affected spaces was never actually initiated as the squad was disbanded and went to the pilot house.

As part of their damage control efforts, the crew attempted to maintain watertight integrity by securing watertight doors. With the crew out of the engine room and mustered in the pilot house, testimony indicates only the starboard side watertight door to the ramp room (Frame 57 ½) was left open. All other watertight doors on the hold deck and main deck were closed.

Testimony also provided insight into the integrity of the vessel's watertight boundaries. On at least two of the doors, those leading into the rudder room and the starboard workshop, the crew used sledge hammers to tighten the dogs and stop leaks.

Certain bulkheads and decks were not watertight as demonstrated by the progressive flooding that took place. The flooding in the ramp room is one example, if it is assumed the water entered the rudder room first. The open drain line from the rudder room into the hydraulics room and the non-tight piping penetration over the rudder room door are also examples.

Technical Analysis of Likely Flooding Scenarios

The MSC conducted an analysis of the flooding and sinking using EBDG'S stability documents and computer model as well as the estimated pre-casualty loading condition. Additionally, certain assumptions and conclusions were drawn based on the testimony of survivors. Two different flooding scenarios were developed that incorporated events described in testimony and bracket the likely flooding scenarios. It is important to note that the analyses completed by the MSC were static and did not account for high winds, heavy seas, sternway, or other variable and dynamic factors that are extraordinarily difficult to reliably model. However, the wind, waves, and vessel sternway would have exacerbated any stability reduction resulting from progressive flooding, downflooding, and large free surface effects.

In the first scenario, flooding starts in the rudder room and progresses to the ramp room, harbor generator room, aft machinery alley and workshop. From this point, the flooding progresses naturally to the lowest points in the vessel: the hydraulics room and the engine room. If the flooding progressed in this fashion, the stern would have eventually been submerged and the trawl deck would have gone awash with the possibility of some degree of downflooding into the fish bin and #4 freezer hold. As the trim by the stern became more excessive and the bow began to rise out of the water, significant listing would have occurred and the vessel would have sunk.

The second scenario follows the same initial sequence of events as the first scenario. After flooding the ramp room, harbor generator room, aft machinery alley and workshop, flooding progresses like the first scenario into the engineering spaces. However, once the water level was approximately 6.8 feet deep in the engineering spaces, a modest amount of water, 50 long tons, was modeled in the factory space. Since the after end of the trawl deck would have been nearly submerged at this point, flooding in the factory is plausible, and, with this water on the deck of the factory space, the vessel assumes a heel angle of 16 degrees. Increasing the amount of water in the factory to 100 long tons is sufficient to fully immerse the trawl deck and the engine room intake vents, quickly leading to the vessel's loss.

Any further development of either scenario is merely speculation and difficult to support with evidence and testimony. However, whether taken individually or considered jointly, the two scenarios, in the context of the earlier stability analysis, illustrate important points about the loss of the ALASKA RANGER.

First, the vessel was inherently stable and would not have sunk had flooding been contained within the rudder room. This demonstrates progressive flooding, resulting from ineffective interior watertight boundaries, led to the sinking. Second, the sequence of the progressive flooding does not significantly impact the outcome. Once the engine room began flooding uncontrollably, the trawl deck went awash and further progressive flooding or downflooding led to the loss of the vessel. Lastly, the substantial starboard list experienced moments before the crew started to abandon ship was likely caused by free surface effects associated with large, partially flooded compartments. Though such a list could be caused by asymmetrical flooding, there is no testimony or evidence of it occurring.

In summary, the analysis demonstrates the vessel would have survived the initial stages of flooding had it been controlled with either sufficient dewatering or adequate watertight boundaries. If flooding had been contained to the rudder room, the vessel would not have sunk. With only the rudder room flooded, the heel would not have changed appreciably, the minimum freeboard would have been almost seven feet, and the height of the lowest downflooding point would have been over eleven feet above the waterline. Even as flooding progressed to the ramp room, harbor generator room, aft machinery alley, and workshop, the vessel would have survived the flooding. The heel would have increased to only four degrees, the minimum freeboard would have been greater than five feet, the lowest downflooding point would have been well over ten feet above the waterline, and the vessel would not have sunk. Once the uncontrolled flooding reached the engine room and exceeded the capacity of the dewatering pumps, the sinking of ALASKA RANGER was assured.

Flooding Rate Assessment

If the ALASKA RANGER dropped a rudder and the rudder post housing was open to the sea, the MSC estimated the initial flooding rate into the rudder room through the 63.6 square inch opening would have been approximately 2,657 GPM. At this rate, it would only have taken approximately 5 minutes to flood the entire rudder room.

An assessment of progressive flooding rates within the interior of the vessel was not undertaken as it would require detailed information regarding the shapes, sizes and locations of every opening in every bulkhead and deck. This information is simply not available. However, the progressive flooding rate can be roughly estimated based on the flooding analysis.

Approximately two hours after the flooding was discovered, the ALASKA RANGER sank. Assuming the flooding was immediately detected by the bilge alarm, there were no dewatering efforts by the crew, and there were sufficient openings in bulkheads and decks to allow water to spread to adjacent compartments, the rate of progressive flooding must have been less than or equal to the rate at which the water entered the hull. In addition, the rate of progressive flooding had to have been sufficiently high enough to result in the vessel's loss two hours after the flooding started.

In the analysis of the first flooding scenario discussed above, the model sank with approximately 1,116 long tons of seawater inside the hull. To fill the hull with this much water in two hours would require an average flooding rate of approximately 2,500 gallons per minute. Similarly, in the analysis of the second scenario, the model sank with approximately 511 long tons on board. This would require an average flooding rate of approximately 1,143 gallons per minute. In each case, the rate of progressive flooding is less than the estimated flooding rate through the rudder post housing.

Even on the low side, progressive flooding rates must have been significant – in excess of 1000 gallons per minute. Small compromises in watertight integrity, like the one inch diameter drain line and the non-tight piping penetration between the rudder room and hydraulics room, have a cumulative effect and could have quickly added up to the area needed to sustain progressive flooding.

Drugs & Alcohol Regulations and Policy

Standards and FCA Policy

Although crew members on inspected vessels face much stricter standards, consumption of alcohol by crew members on board a fishing vessel is not prohibited by USCG regulations. However, 33 CFR 95 prohibits an individual from “operating” a fishing vessel if the person has a blood alcohol concentration of 0.04 percent by weight or more, or the effect of the alcohol is apparent by observation of the person’s manner, disposition, speech, muscular movement, general appearance, or behavior.

Neither law nor regulation limits the authority of the marine employer to limit or prohibit the use or possession of alcohol on board a vessel. FCA had a “zero-tolerance” drug and alcohol policy in their employee contracts and employee handbook. FCA’s policy prohibited employees from using drugs and alcohol while under contract and stated chemical testing and searches for contraband were permitted. Further, the contract stipulates the Captain of the vessel may terminate employment at any time for alcohol use or possession on board or while under contract, implying this prohibition applied to the employees even while ashore if they remained on contract. While the policy stated the Captain may terminate employment, the previous Captain stated that the policy concerning alcohol use was to report the incident to the company.

Alcohol Use

The Night Engineer admitted he drank while at sea, but stated he never drank while on watch.

The Chief Cook, who started working on the ALASKA RANGER in 1994 and spent more than 3000 days at sea aboard the vessel, told the MBI that the Night Engineer “should probably not be on the boat” because of his drinking. He had told the previous Captain he had observed the Night Engineer intoxicated while on the vessel. According to the Chief Cook, the previous Captain required the Night Engineer to report to him every night before going on watch so he could confirm he was not intoxicated.

The previous Captain testified he had never seen the Night Engineer drinking while aboard the vessel. He did recall receiving a report from the Chief Cook concerning the Night Engineer’s drinking. He testified that he questioned the Night Engineer, who denied the allegations. The previous Captain then stated he told the Night Engineer he would immediately be subjected to alcohol testing if the Captain received any additional reports and instructed him to report to the Captain and Mate 15 minutes before the start of each of his shifts.

Testimony from other survivors indicates other crew members also drank alcohol while at sea.

Post Casualty Testing

Post casualty chemical testing was not completed as required. 46 CFR 16.240 requires the marine employer to ensure that all persons “directly involved” in a “serious marine incident” are chemically tested for evidence of dangerous drugs and alcohol.

The casualty resulted in four deaths and one person missing and presumed dead, as well as the total loss of the ALASKA RANGER, a U.S. flagged vessel greater than 100 gross tons. As a result, it was a “serious marine incident,” as defined in 46 CFR 4.03-2.

Per 46 CFR 4.03–4, an individual “directly involved” in a serious marine incident is an individual whose order, action or failure to act is determined to be, or cannot be ruled out as, a causative factor in the events leading to or causing a serious marine incident.

As the marine employer, FCA was required to ensure all personnel directly involved in the casualty underwent post casualty chemical testing. The Mate and Night Engineer, who were on watch, and the Captain and Chief Engineer, who directed activities after flooding was discovered, were directly involved in this casualty and were required to be tested for evidence of drugs and alcohol.

The Captain, Mate, and Chief Engineer underwent post mortem chemical testing, and the results were negative for each of them. The Night Engineer was recovered by the ALASKA WARRIOR, which had chemical and alcohol testing equipment on board, but he was not tested. The Captain of the ALASKA WARRIOR testified he was aware of the post-casualty testing requirements, but, with all of the other search activity, he did not even think to have him tested. FCA did not direct the ALASKA WARRIOR to conduct testing.

The USCG did not direct FCA to conduct post casualty testing. As discussed above, it is the Marine Employer's responsibility to have each individual directly involved in a serious marine incident chemically tested for evidence of drug and alcohol use. However, the USCG should ensure marine employers are aware of, and meet, that responsibility and assist as necessary with determining who is directly involved in the incident. On 11 December 2008 CGHQ sent a message to Sector Commanders and Investigating Officers that re-emphasized the importance of reminding marine employers of the post casualty testing requirements whenever a serious marine incident occurs.

Vessel Manning and Operations

Manning

The Master and Mate were properly licensed. The Chief Engineer and the two assistant engineers were not.

Per 46 USC 8304, a person may only serve in the capacity of master, mate, or engineer on a self propelled commercial vessel over 200 GT that operates beyond the Boundary Line if that person is properly licensed for that particular service. Since the ALASKA RANGER was a self-

propelled, documented vessel over 200 GT and operated beyond the Boundary Line, anyone serving as master, mate, or engineer on board the vessel was required to be licensed.

46 CFR 15.825 states that an individual in charge of an engineering watch on a mechanically propelled, seagoing, documented vessel of 200 gross tons or over, other than the Chief Engineer, must hold an appropriate license authorizing service as an assistant engineer.

The ALASKA RANGER employed three engineers, two assistant engineers that stood 12-hour watches and one licensed chief engineer that was not a watch stander. Though not required by law or regulation, FCA elected to establish an engineering watch, and the requirements of 46 USC 8304 and 46 CFR 15.825 applied. As a result, the watchstanding engineers on the ALASKA RANGER should have held the appropriate licenses.

The Night Engineer did not hold a USCG license. Though the Day Engineer and Chief Engineer were licensed, neither of them held the proper license and endorsements to serve on board the ALASKA RANGER because they lacked sufficient minimum horsepower ratings. The total horsepower of the ALASKA RANGER was 7040 HP with each main engine rated for 3520 HP. The Chief Engineer was licensed for “Chief Engineer of Uninspected Fishing Industry Vessels of Not More than 6000 Horsepower” and the Day Engineer held a license endorsed for “Assistant Engineer of Uninspected Fishing Industry Vessels of Not More Than 4000 Horsepower.”

Operations in Ice

The vessel’s repair history indicates the forepeak had likely been damaged from operating in ice. While in drydock in 2007, a number of repairs were made to the hull plating and framing in way of the forepeak.

The ALASKA RANGER operated in ice during earlier fishing trips in 2008. There is conflicting testimony regarding the severity of the ice, its impact on the vessel, and the speed of the vessel while in the ice. However, any damage to the bow and forepeak tank from ice was not likely a contributing factor in this casualty because the flooding initiated at the stern.

At least two crew members and one NMFS observer testified the vessel had been sailed very fast through the ice, which could be heard banging against the hull. One crew member provided photographs and video of the vessel in the ice.

The previous Captain testified the ALASKA RANGER encountered ice on all three trips he made in 2008. He stated the vessel could only go approximately 3 ½ knots when in unbroken ice or else the autopilot would not stay on course. He indicated the vessel operated at a safe speed at all times, never went astern in the ice, and, though ice was scraping against the hull, ice was never banged against the hull. He told the MBI, “Well, it [ice] changed as the winter went on. Originally the floes come down and they are narrow strips, very thin, broken ice. No problem. By the end the last trip was still floes, but they were more solid and it was getting thicker.”

The previous Captain also explained that the ALASKA RANGER “didn’t fish through the ice per se.” They would only fish during daylight, when they could find clearings in the ice. This

testimony was corroborated by the Operations Manager, who previously served as Captain and explained the ice would foul the fish net and gear, making attempts to fish at night unproductive.



Figure 31: Photograph of ice encountered by the ALASKA RANGER in February 2008

The MBI consulted with the naval architects at the USCG Engineering Logistics Command, which provides engineering design, support and repair assistance to USCG cutters, including the USCG's fleet of ice breakers. They reviewed the evidence and testimony, and indicated ALASKA RANGER would not likely have sustained severe damage to the stern appendages of the vessel. Though vessels operating in ice sometimes experience damage to the stern, it normally occurs when vessels make large turns or back down in ice.

Role of the Fish Master

The previous Captain testified that he would occasionally leave the Fish Master alone in the pilot house while he went below to check the factory, and, at times, he would take helm and speed commands from the Fish Master. Based on a review of USCG Commandant Decisions on Appeal (CDOA), which are the agency's final rulings on suspension or revocation of merchant mariner licenses, such actions were in violation of law.

The Master and officers in charge of a deck watch on a U.S. documented vessel must be U.S. citizens and properly licensed. In CDOA 2058, the Commandant found the temporary absence of the licensed operator does not necessarily mean the licensed officer has relinquished control of the vessel.

However, related decisions (CDOAs 2122 and 1887) state that if something unexpected occurred while the licensed officer was away from the pilot house, control of the vessel may be relinquished. When ice conditions changed unexpectedly and the Fish Master failed to recognize the need to slow the vessel, requiring the Captain to return to make the changes, the Captain relinquished control to the Fish Master, an unlicensed non-U.S. citizen, in violation of 46 USC 8103 (a) and 46 USC 8304.

In addition, the previous Captain testified the Fish Master sometimes gave him helm and speed commands. This was a violation of 46 USC 8103 (a) and 8304 as the Captain effectively relinquished control of the vessel to an unlicensed non-U.S. citizen. In CDOA 2465, the Commandant found a pilot negligent for relinquishing control of the vessel when he allowed the vessel's master to make his own course and speed changes.

Safety Training and Equipment

Instruction, Drills, and Training

46 CFR 28.270(a) requires the Master or person in charge of each fishing vessel to ensure drills are conducted and instructions are given to each individual crew member at least monthly. There are ten elements that must be addressed in the monthly drills and instructions, including: (1) abandoning the vessel; (2) fighting a fire; (3) recovering an individual from the water; (4) minimizing the effects of unintentional flooding; (5) launching survival craft; (6) donning immersion suits; (7) donning a fireman's outfit and a self-contained breathing apparatus; (8) making a voice radio distress call and using visual distress signals; (9) activating the general alarm; and (10) reporting inoperative alarm systems and fire detection systems.

Aboard the ALASKA RANGER, the monthly training focused largely on mustering and donning survival suits. The other elements of the required instructions were not provided monthly, and when provided were provided only to members of the Emergency Squad, not to all hands.

Despite this focused training, the MBI identified one crew member who had never donned an immersion suit before the general alarm sounded on 23 March 2008. That crew member had joined the vessel just before it departed Dutch Harbor and had no prior fishing experience. In addition, he did not know and understand the alarms used onboard the vessel. When the general alarm sounded, he thought it meant it was time for him to report to work in the factory rather than go to his muster station. Another crew member testified he did not receive training on how to survive in the water.

Several crew members did testify that drills had been conducted on occasion and included training on dewatering and fire fighting. However, testimony also revealed that only the emergency squad received this training. At the one drill, witnessed by NMFS Observer #1, no

hands-on training was conducted; the drill was limited to questioning the Emergency Squad as to their duties.

This situation was exacerbated by FCA's lack of written training procedures ensuring all the required onboard training was conducted. The unintended result was that training procedures changed on the vessel whenever the Captain changed. For example, the Chief Cook testified that the previous Captain only wanted a captain, mate, or engineer to launch the liferafts and did not provide instructions to all crew members on how to launch them. Similarly, the Factory Leader testified that during drills it was emphasized that an officer would launch the liferafts, but that everyone needed to know how to launch one. When the previous Captain was asked about the Chief Cook's comments, he testified that he only trained the emergency squad how to launch the liferafts. This was despite the fact 46 CFR 28.270 requires all crew members to be trained to launch liferafts.

FCA'S Role in Instruction, Drills, and Training

FCA did not have a written training program, and did not conduct audits of the training being provided on each vessel. Similarly, FCA did not have written emergency procedures for the crew to follow during emergency situations. A written training program and written emergency procedures are not required. FCA expected that licensed officers would know and comply with any applicable regulations or follow good marine practice.

While FCA did send some crew members to shore side training courses, no additional advanced training was required or provided to licensed officers with the exception of the Drill Conductor Course. FCA did not provide training in emergency response, damage control, or fire fighting to the officers. In this regards the Operations Manager testified "the deck officers or chief engineers, that had licenses, that would allow them to sail on these vessels, had to pass the requirements set by the USCG on training in order to receive their license." The implication was they already knew what they needed to know, and FCA did not need to invest any further efforts to improve their professionalism or seamanship.

FCA did not have a safety budget. FCA did, however, send some personnel to the Drill Conductor Course³ to meet regulatory requirements and occasionally sent some personnel to courses designed to meet the standards of STCW for basic training. These courses, approved by the USCG, included launching a liferaft, donning a survival suit, entering the water in the survival suit and boarding a liferaft.

Despite the lack of a dedicated safety budget and a written training program, the CFVS Examiners who conducted safety examinations on FCA vessels testified that the company's

³ 46 CFR 28.270(c) requires personnel conducting training and drills onboard commercial fishing vessels, known as Fishing Vessel Drill Conductors (Drill Conductors), to meet specific training requirements. To be assured of meeting the training requirements of 46 CFR 28.270(c), Conductors who are not licensed to operate an inspected vessel of 100 gross tons or more must be trained by a Fishing Vessel Safety Instructor that has been accepted by the local OCMI. This training is commonly called the Drill Conductor Course.

employees were professional and cooperative when addressing matters related to safety. One examiner even stated that FCA “always demonstrated concern with regards to safety.”

Vessel Emergency Squad

On each voyage, six or seven crew members were selected to be part of the emergency squad and assigned specific duties when called upon to respond to emergencies such as fire or flooding. On this voyage, the emergency squad consisted of seven men, including the Bosun, three Factory Workers, the Factory Manager, a Deckhand, and the Factory Leader. Three had attended a five-day USCG approved STCW basic safety training course, and a fourth had been to a two-day firefighting course. Four members of the emergency squad had also attended the Drill Conductor Course. Two had no shore side emergency training.

Emergency Communications Equipment

The Captain and the Mate maintained effective communications with the USCG throughout the emergency. Portable handheld radios reached at least one liferaft, enabling the ALASKA WARRIOR and the USCG to communicate with the survivors in the liferaft.

The vessel had a Global Maritime Distress Safety System (GMDSS), Very High Frequency (VHF) and High Frequency (HF) single side band radios, and satellite telephones. The vessel carried a 406 Mhz Emergency Position Radio Indicating Beacon (EPRIB), two 9 GHz Search and Rescue Transponder (SART) beacons, and three handheld VHF survival radios.

At least one HF single side band radio, VHF radio, and GPS unit were provided emergency power via a 12-volt DC system.

Communications seemed to be working properly at the time of the casualty. The ALASKA RANGER remained in contact with the USCG until it sank. However, the Captain of the ALASKA WARRIOR reported that his GMDSS did not automatically receive the name of the ALASKA RANGER.

The crew activated the EPIRB manually, and it transmitted throughout the event. The NMFS Observers each had a personal EPIRB. Both were activated and transmitted properly. These EPIRBs provided the USCG the exact locations of each observer. Due to the circumstances in this case, the liferafts were found visually, and the data from the EPIRBs was not used.

Liferafts

The ALASKA RANGER was equipped with three new Viking 20-person inflatable liferafts. The liferafts had been manufactured in April 2007 and installed on 24 August 2007. The rafts were mounted outside the pilot house with two on the starboard side and one on the port side. Each raft was outfitted with a hydrostatic release.

The ALASKA RANGER had an embarkation ladder positioned at the port and starboard embarkation stations on the shelter deck. The ladders were intended to facilitate boarding of

liferafts by allowing crew members to climb down from the shelter deck to the waiting liferafts. The liferafts should have been positioned under the embarkation station by tying the liferaft's sea painter to the vessel's railing while making headway.

There were seven crew members on board the vessel that had attended Drill Conductor training: the Captain, Mate, Night Engineer, Bosun, Factory Leader, and two Factory Workers. The Bosun and the two Factory Workers were assigned to liferaft #1. The Bosun launched the liferaft, and reported it was easy to launch. The Mate and the Night Engineer were assigned to liferaft #2. The Mate and NMFS Observer #1 launched liferaft #2, and the NMFS Observer reported the launching went properly.

The Factory Leader was assigned to liferaft #3, but did not assist with launching the liferaft. The Chief Cook, who had not been trained, launched liferaft and reported having difficulty. Due to the ice covering the releasing gear and insufficient lighting, the Chief Cook had trouble getting to the releasing gear. In addition, the gloves on the survival suit made it difficult to work the releasing gear.

Survival Suits

The survival suits on board the ALASKA RANGER were stored in deck boxes outside the wheelhouse. Each survival suit was stowed in an individual bag, with the color indicating the size. Survival suits were not assigned to specific crew members.

Not all crew members received survival suits that were the correct size. As a result, some of the larger people had difficulty putting on the survival suits. Several of the smaller crew members received suits that were too large, allowing excessive water to enter the suit. For example, the Captain was wearing a "jumbo" suit even though he was relatively small compared to other crew members. Similarly, the survival suits provided to the crew member who fell from the rescue basket of the HH-65, the Mate, and three severely hypothermic survivors that lost consciousness were filled with water and likely too large.

Of the 44 survival suits recovered after the casualty and examined by the MBI, 32 were manufactured by Stearns, nine by Imperial and three by Viking. All three manufacturers manufacture a universal survival suit rated for persons up to 75 inches tall and weighing between 110 and 330 pounds. 33 of the suits were Adult Universal. Seven were Adult Intermediate manufactured by Imperial and rated for persons 59-70 inches tall and weighing between 110-180 pounds. Three were Adult Oversize manufactured by Stearns and rated for persons up to 75 inches tall and between 220-375 pounds. One was a Jumbo manufactured by Imperial and rated for persons over 75 inches tall and over 330 pounds.

Several crew members reported taking water into their survival suits once in the water. At least two survival suits took on so much water that the survival suits were purposely cut to drain water to facilitate recovery, and an attempt was made to cut a third survival suit. The USCG HH-60 cut the feet of the survival suit of a non-responsive crewmember in order to drain water from the survival suit and enable the helicopter crew to pull the crewmember into the helicopter. The Flight Mechanic in the USCG HH-65 attempted to cut the suit of Crew Member A in an attempt

to get him into the helicopter. Personnel on the ALASKA WARRIOR had to cut the suit of another crew member in order to recover the man. In Figure 32, the midsection and legs of the survival suit of one survivor are much too large and his right foot does not reach the survival suit boot.

The water in these survival suits might be attributed to being in the ocean under conditions other than flat calm seas. Alternatively, the survival suits may not have fit correctly, may not have been donned properly, or may have leaked through seams or holes in the suits. Water may have also gotten into the survival suits due to the activities of crew member while in the water (e.g. swimming).



Figure 32: Photograph of rescued ALASKA RANGER crew member in survival suit

Two crew members testified their suits contained water and/or were damaged before they donned them. The MBI inspected the suits after the casualty and generally found the suits in acceptable condition. The tears, cuts, and areas of worn material on the suits could not be conclusively linked to the condition of the suit before the casualty.

Table 46 CFR 28.120 requires survival suits to be inspected, cleaned and repaired as necessary, at least annually. The USCG CFVS Examiner who in January 2008 conducted the ALASKA RANGERS last exam testified all survival suits were visually examined and, with the exception of several that were over ten years old, the suits were in satisfactory condition. He required FCA to replace the older suits.

The Operations Manager testified that there was no “hard and fast rule” for ensuring the vessel had the correct sized suits for the crew that was actually aboard the vessel for a specific voyage. He testified that while he was Captain, he would adjust the survival suit inventory based on the approximate sizes of the crew on hand. He used the example that if the vessel had three jumbo suits on board, and the incoming crew change brought six large people, he would call the safety equipment supplier and purchase additional jumbo suits. He also said that if the next crew change brought different size people, the survival suits would be reviewed to ensure they were the appropriate size for the crew on hand. Extra suits would not be returned or stored ashore, creating a surplus of suits on board.

As part of ACSA, the survival suits were fitted with strobe lights. Rescuers reported that the strobes were easy to see and were effective in the rescue operations. However, some survivors testified that the strobe lights on some suits either did not work or fell off the suit when the individual entered the water.

Of particular note is that both NMFS Observers testified they had little or no problems with their survival suits, which they brought on board with them. They attributed this to the fact that they were sized for their suits and trained in their use before embarking on any fishing vessel.

Bilges and High Level Alarms

The bilge high level alarm system included an engine room alarm panel, a pilot house alarm repeater, an alarm repeater in the house, and the bilge high water actuators. The bilge alarm panel in the engine room was located at the forward end of the engine room and included an audible alarm and a light panel. The light panel had individual lights corresponding to each space with one or more actuators (e.g. bow thruster room, rudder room, etc.). When a bilge accumulated enough water to activate an actuator, the alarm would sound and energize a light showing the compartment triggering the alarm.

The pilot house had an audible alarm and single light that lit whenever an engine room alarm activated. This was a common repeater connected to many engine room alarms including the bilge high level alarm system. The officer of the watch would need to speak with the engine room watch to determine what alarm was sounding and why. The pilot house could acknowledge the alarm, which would silence it, but the light would remain energized until the condition returned to normal.

There were bilge high level alarm actuators in the bow thruster room, forward and aft portions of the engine room, the hydraulics room, and rudder room alley way. The engine room system did not include the factory.

According to vessel plans, the bilges in the engine room were approximately ten feet deep. While the exact height above the bilge of the high level alarm actuators is unknown, the electrician that worked on the system testified the engine room actuators were five to seven feet above the bilge bottom and the actuator in the forward portion of the rudder room near the watertight door was three to four feet above the bottom. This would allow a significant amount of water in the bilges before an alarm would sound.

There are no standards in regulation, policy, or ABS class rules regarding placement of high level alarm actuators in relation to height above the bottom.

Safety Culture

Compliance with the Trim & Stability Booklet

In addition to providing the Captain the ability to calculate the reserve buoyancy of the vessel, the stability booklet provided specific instructions on the order of use, and operating conditions of, fuel oil tanks, fresh water tanks, ballast tanks, etc.

The previous Captain did not follow that guidance. He testified he left the decisions related to how tank capacities were managed to the engineers and did not use the stability booklet to determine the order or sequence for burning fuel oil. He also testified that the engineers did not consult the stability booklet and that, from time to time, they would take suction from more than one set of tanks if the vessel had a list, despite the restrictions in the stability booklet that “No more than one centerline or P/S pair of each of the following consumable tanks may be partially filled at any one time: fuel oil day, fuel oil storage, lube oil, fresh water, and hydraulic oil tanks.”

The stability booklet also had an important safety note directing the Captain to verify the stability of the vessel when the #4 fuel oil tanks were empty. Since there was no communication between the Captain and the engineers regarding fuel usage, it is likely that this requirement was not followed.

The vessel’s trim and stability booklet also stated: “The vessel's bilges and voids shall be kept pumped to minimum content at all times consistent with pollution prevention requirements.” It is the responsibility of the Captain to ensure crew members know, understand, and comply with the instructions in the stability booklet, and remove bilge accumulation whenever it exceeds the normal working accumulation.

Yet the Night Engineer testified the bilges were so deep they only needed to be pumped dry once a month and that it was his practice to wait until the high level alarm sounded before pumping the bilges. With the engine room high level actuators five to seven feet above the bottom of the bilges, this practice allowed an unnecessarily large accumulation of liquid in the engine room bilges before any alarms sounded, and conflicted with the guidance in the stability booklet, jeopardizing the safety of the vessel.

Watertight Doors

ACSA required that doors in watertight bulkheads be kept closed at sea except when crew members needed to pass through the doors. This requirement was not implemented aboard the ALASKA RANGER. The Day Engineer testified that all watertight doors in the engineering spaces on board the ALASKA RANGER, except for the two watertight doors into the factory, were latched open with a hook. While the Night Engineer testified that he closed the watertight doors when he was on watch, the Bosun, who was the first to enter the engine room after the

alarm was sounded, found the doors on the main deck open with the exception of the door from the factory to the ladder trunk.

FCA's Operation manager stated to the MBI, "To me, telling a licensed deck officer that he needs to maintain his watertight doors in an operable condition is like reminding a child to eat. You shouldn't have to go there." Yet, many watertight doors on the FCA vessels were not maintained.

When the Sector Seattle CFVS Examiner attended the ALASKA RANGER in Japan in November 2007, the vessel received a written requirement to conduct maintenance on all watertight doors, to develop a preventative maintenance schedule and log for each of the closures listed in the Stability Addendum, and to conduct repairs on maintenance to at least 13 doors, hatches, and closures.

When the ALASKA RANGER returned to Dutch Harbor on 20 March 2008, the Captain told the Day Engineer that they needed to start a watertight door preventive maintenance program. The Day Engineer testified he was assigned to check the doors and needed to get the dogs in working order "because we hadn't started on them." Although he had adjusted and replaced dogs before and checked gaskets on other vessels, he had no training and did not know how to chalk the doors and check for proper closure and fit.

Alcohol Use and Substandard Watchkeeping

As discussed in the "Drugs and Alcohol Regulations and Policy" section, despite FCA's "no tolerance" policy, some crew members consumed alcohol aboard the vessel while at sea. Although the MBI did not find evidence that he was under the influence of alcohol the night of the casualty, other crew members had observed the Night Engineer under the influence of alcohol while on watch.

In addition, the Night Engineer was known to sleep while on duty. Evidence and testimony indicates various crew members had observed the Night Engineer asleep in the galley or engine room at night while on watch. A video taken by other crew members as part of a prank shows the Night Engineer sleeping in the engine room beside the previous Chief Engineer, who was also asleep, while the vessel was underway in December of 2007. One factory worker described an incident where an alarm registered on the flow scale in the factory and he went to the engine room seeking assistance from the Night Engineer and found him asleep with an alarm light flashing in his face.

Crew Performance

Damage Control

The officers and crew did little to save or prolong the life of the ALASKA RANGER. The Chief Engineer, the unlicensed Night Engineer, the Emergency Squad, and two Japanese foreign fisheries specialists went to the engine room in response to the flooding, yet accomplished very little. The other experienced engineer, the Day Engineer, never went to the engine room. From

the time flooding was discovered until the ship sank approximately two hours later, damage control efforts by crew members consisted of the following activities:

- The Night Engineer dogged the watertight door to the rudder room after responding to the high bilge alarm. He started the bilge pumps and fire pump, taking suction on the ramp room, the hydraulics room, and the engine room, while opening the sea suction a small amount to prevent the pumps from running dry and becoming damaged.
- The Chief Engineer went to the engine room, stayed a few moments, and then ordered others to cease efforts to control the flooding and evacuate the space.
- The Emergency Squad went to the engineering spaces, gathered the portable dewatering pump, and began to set it up. However, they departed the engineering spaces before starting the pump at the direction of the Chief Engineer. Though the exact reasoning could not be confirmed, the Chief Engineer likely ordered the engine room abandoned because he either concluded the amount or rate of flooding far exceeded the capacity of the pump or he simply panicked.
- The Japanese Chief Engineer went to the engine room and joined the Night Engineer. They closed one of the two watertight doors to the ramp room despite the rapidly rising water in the space. Before going to the pilot house to muster, the two men hammered the dogs tight on the rudder room watertight door to minimize leakage, hammered the watertight door to the tool room closed, and checked the overboard discharge chutes in the factory to ensure they were closed.
- When the Night Engineer returned to the engine room with the Captain, he ensured the watertight doors on the trawl deck were closed.

Abandon Ship

After the vessel suddenly rolled to starboard, the Captain and Mate began telling the crew to abandon ship. Liferafts #1 and #2 were released easily. The Factory Leader had received drill conductor training and was assigned to liferaft #3, but did not attempt to launch it. The Chief Cook launched it, and despite the ice accumulation on the launching apparatus and being unfamiliar with the equipment, he was able to do so.

As the liferafts were launched, the ALASKA RANGER began backing down. Liferaft #1 shot past the bow and the sea painter line parted under the strain. After liferaft #2 was launched, the sea painter appeared to part, and the crew did not believe it inflated. Almost immediately after the apparent loss of liferaft #2, liferaft #3 was being dragged from the bow as the vessel started going astern. The Mate reported to the USCG that all liferafts had been lost.

While regulatory requirements exist that mandate vessels conduct emergency drills, including abandon ship, there are no requirements to have emergency procedures to follow when abandoning ship. Written procedures that address anticipated scenarios and conditions can be provided to assist the Captain or person in charge and can be practiced during drills and training to provide consistency during an emergency. In this case, there were no procedures, and the Captain and Mate were evaluating the conditions and making decisions based solely on their personal knowledge and experience.

The officers and crew must maintain situational awareness at all times during an emergency, and take into consideration the vessel's position, speed, heading, heel, trim, and other relevant factors that may impact their safety. They must understand how vital machinery and communications systems are powered and the impact flooding or fire may have on the equipment. The Captain and the Mate aboard the ALASKA RANGER may not have been aware the vessel could go astern if the CPP system lost hydraulic pressure and the main engines continued running. In addition, the Captain and Mate may not have known remote main engine shutdowns were located in the pilot house, and the Night Engineer also apparently forgot they existed.

The failure to shut down the engines, either before the order to abandon ship was given, or immediately after learning the ship was going astern, prevented the orderly evacuation of the ship to the liferafts. Of the 22 people who boarded liferafts, all survived. Of the 25 who did not, 5 died.

Various actions by individuals to assist others before they abandoned ship likely prevented additional deaths. For example, the two men who had just joined the vessel and never before donned a survival suit or participated in an abandon ship drill were helped by other more experienced crew members. One crew member who had received STCW training before coming to work with FCA instructed at least one other shipmate how to survive in cold water.

Once the vessel was abandoned, some crew members managed to swim to liferafts, others rafted together, while others drifted off by themselves. Several crew members assisted each other by helping individuals get clear of floating debris, locating and entering life rafts, or holding on to one another and simply sharing words of encouragement and support.

Search and Rescue Operations

USCG Hoisting Procedures

The USCG uses three methods to recover rescue swimmers and survivors: strop, rescue basket, and double lift.

When using the strop recovery method, the rescue swimmer never unhooks from the hoist throughout the evolution. The swimmer is lowered via the harness, with the strop connected to the rescue hoist hook. When the swimmer reaches the water, the helicopter has the option to pay out slack in the hoist cable to provide a catenary so it can move away from the swimmer and survivor to avoid overcoming the people in the water with the rotor wash and to ensure the rise and fall of the waves does not inadvertently lift the swimmer from the water. Once in the water, the swimmer swims to the survivor, slides the strop over the head and arms and under the armpits of the survivor and clinches it tight. The swimmer and survivor are hoisted together to the aircraft. Typically, the strop recovery method takes approximately three to five minutes to recover a person from the water.

When using the rescue basket recovery method, the rescue swimmer will normally deploy to the water and swim to the survivor. When the survivor is ready to be hoisted, the rescue swimmer will use hand signals to notify the flight mechanic. The rescue basket is then lowered to a

location approximately five to ten feet from the survivor and rescue swimmer. The rescue swimmer brings the survivor to the basket, and loads the survivor into the basket. The rescue swimmer uses hand signals to inform the flight mechanic the survivor is in the basket and to begin the hoist. While the rescue basket is outfitted with buoyant floats, the basket may tilt or lay to one side due to the slack cable that must be paid out to keep the rise and fall of the waves from continuously lifting and dropping the basket. Once the rescue swimmer is in the water, it normally takes one to three minutes to recover a survivor using the rescue basket method.

For hoisting severely hypothermic survivors, the USCG does not normally use the rescue basket or a quick strop because a sudden blood drain from the torso to the legs may cause cardiac arrest. Instead, the USCG uses the double lift recovery, where the swimmer wraps a strop around the chest and another around the survivor's legs, pulling the legs against the survivor's chest. However, this procedure may be difficult and time consuming. According to the USCG HH-65-C Flight Manual, the rescue swimmer may require up to 20 minutes to place both strops around the survivor and prepare for the hoist.

Prior to deploying a rescue swimmer, the helicopter crew completes an initial evaluation and briefing that addresses on scene conditions, performance factors (such as fuel state, power available/required), a review of normal and emergency procedures (engine malfunction, lost communications, fouled cable, etc.), and the rescue method to be used.

Once the rescue swimmer is deployed the helicopter moves to a position where the pilot can see the rescue swimmer (during hoisting and whenever the swimmer is underneath the helicopter the pilot is unable to see the rescue swimmer). While the rescue swimmer is deployed, the duties of the flight mechanic include keeping the swimmer in visual contact, communicating with the swimmer using a series of standard hand signals, and giving the pilot the direction and distance to the swimmer's position.

USCG rescue swimmers carry a handheld radio in their harness, but due to the environment they work in, and the way the radio is positioned, they normally only use the radio when they need to call the helicopter. It is difficult for the helicopter crew to initiate contact with the swimmer.

When the rescue swimmer gives the "READY FOR PICKUP" signal, the flight mechanic will give conning commands to the pilot to place the basket five to ten feet from the swimmer and survivor. The rescue swimmer swims the survivor to the basket, places the survivor in the basket in the sitting position, and gives the "READY TO BE HOISTED" signal. The flight mechanic takes the load and completes the hoist. The intent is to minimize the time that the rescue swimmer and survivor are underneath the helicopter.

Proficiency Requirements

The USCG has extensive proficiency requirements for pilots, flight mechanics, and rescue swimmers. With regard to rescue swimmer deployment and recovery, pilots must perform six rescue swimmer deployment and recovery sequences every six months, four of which must be at night. Flight mechanics must perform four rescue swimmer deployment and recovery sequences

every six months, two of which must be at night. Rescue swimmers must deploy six times per quarter. Operational deployments count towards the minimum requirements.

To meet the requirements, USCG AIRSTAs typically schedule training sessions where two rescue swimmers are deployed in the water (by helicopter or utility boat). One will use the other as the “survivor” as a helicopter performs multiple hoists, rotating mechanics and pilots so that multiple personnel can complete the prerequisite hoists as efficiently as possible. Rescue swimmers are deployed in their dry suits. They do not demonstrate proficiency using “survivors” outfitted in immersion suits, which may fill with water and be more cumbersome. In addition, there are no requirements for the “survivor” to be non-responsive, uncooperative, or combative. Some USCG AIRSTAs use rescue mannequins as survivors to replicate non-responsive “survivors.”

Experience

The Flight Mechanic on the HH-65 had been in the USCG for nine years and a qualified HH-65 flight mechanic for six years. In addition to meeting all proficiency requirements, he had previously conducted two rescue hoists. One involved hoisting a person stuck on rocks along the Oregon coast, and the other involved hoisting a person off a ship.

The Rescue Swimmer on the HH-65 had been in the USCG for approximately two years, spending much of that time completing the training requirements to become a rescue swimmer. In addition to meeting all proficiency requirements, he had previously conducted one rescue where the helicopter landed on the beach and he waded out to the boat in distress. It did not involve a hoist.

The Loss of Crew Member A

When the HH-60 arrived on the scene of the ALASKA RANGER sinking, it recovered the first two survivors using a strop because the Aircraft Commander was concerned he might lose the Rescue Swimmer. However, it was difficult to maintain position over the swimmer and took longer than expected to recover the first two survivors. When the HH-60 got to the second group of people, the aircrew discussed the situation and agreed that it would be quicker and more efficient to put the swimmer down and let him tend to the survivors there. The swimmer stayed with the survivors, bringing them one by one to the rescue basket. It ended up being much more efficient.

When the HH-65 arrived on scene, it used the rescue basket immediately. With three survivors already in the helicopter, the HH-65 found Crew Member A and the Day Engineer and deployed the Rescue Swimmer and rescue basket to recover them.

When the Rescue Swimmer reached the two men, he decided to recover Crew Member A first because he appeared to be in worse condition. The Rescue Swimmer had great difficulty getting Crew Member A into the basket and keeping him in it. Crew Member A would be in the basket and then a wave would wash over the basket and knock him out of the basket. Throughout the

rescue, the swimmer, Crew Member A, and the basket were dragged through the water several times as the basket went down swell and the cable became taut.

In the helicopter, things were not going as smoothly as they did with the earlier hoists. Due to the weather and lack of a visual reference for the pilots, the HH-65 was having a difficult time maintaining position and the crew lost sight of the swimmer and Crew Member A at least four times. Further complicating the situation were the seas that were pushing the Rescue Swimmer and Crew Member A back underneath the helicopter and toward tail. According to the Flight Mechanic, as the Rescue Swimmer and Crew Member A were pushed back, the hoist cable was dangerously close to getting wrapped around the landing gear. It is nearly impossible to free the hoist cable while airborne due to the potential risks of chaffing brake lines and other problems. Throughout the rescue effort, the Flight Mechanic listened as the pilots discussed the helicopter's limited fuel supply.

According to the Flight Mechanic, he finally saw Crew Member A in the basket, with the basket in a position it could be hoisted without undue stress. Concerned that they had very little time left on scene before returning to the CGC MUNRO for fuel, the Flight Mechanic decided to initiate the hoist and gave the pilot the command "taking up slack, prepare to take the load" and started to hoist Crew Member A despite never receiving the "ready to be hoisted" signal from the Rescue Swimmer.

As the basket came out of the water, Crew Member A's legs were outside of the basket, and he appeared to be sitting on the top rail along the length of the basket, with his head and shoulders through the triangle formed by the lifting bale, as illustrated in Figure 33. As the hoist began, Crew Member A looked stable to the Flight Mechanic and the Rescue Swimmer began swimming to the next survivor to be hoisted.

As the basket was raised, Crew Member A began to slide off the top rail of the basket. He was still hanging onto the lifting bale with his arms, but his bottom slid off of the rail of the basket. When it appeared the survivor was not secure in the basket, the Flight Mechanic could have lowered the basket back to the water in an attempt to prevent a fall. This would not have been without risk. The helicopter would not have been able to move to the next survivor until the swimmer returned to assist Crew Member A or until Crew Member A got into or entirely out of the basket.

The Flight Mechanic knew the helicopter was running low on fuel and was very short on time. The Flight Mechanic continued the hoist.

When the rescue basket reached the side of the helicopter, Crew Member A was hanging onto the basket but was no longer inside it. As a result, the Flight Mechanic could not pull the basket into the cabin. Due to the weight of the water in his survival suit, the Flight Mechanic was unable to physically lift Crew Member A into the cabin. As the Flight Mechanic turned to grab a knife, or shroud cutter, to cut the suit to drain the water, Crew Member A fell from the basket. At that time the pilot was trying to maintain a hover altitude of 60 feet. Depending on the swells, the helicopter may have been anywhere from 40 to 80 feet above the water when Crew Member A fell.

The pilot of the HH-65 spotted Crew Member A face down in the water, but was unsuccessful in his attempts to alert the Rescue Swimmer and have him return to Crew Member A.

Crew Member A would later be recovered by the ALASKA WARRIOR and declared dead. The personnel who attempted to revive Crew Member A stated they did not see any physical injuries on his body.



Figure 33: Photograph of LTJG [REDACTED] demonstrating position of Crew Member A

The Flight Mechanic deviated from written procedures in Commandant Instruction CGTO IH-65C-1, the H65 Flight Manual, and began to hoist before the rescue swimmer provided the “ready to be hoisted” signal. The Flight Mechanic’s decision to commence the hoist was based on several factors including the on scene weather conditions, sea state, Crew Member A’s difficulty getting into the basket, the limited time left on scene due to the helicopter’s dwindling fuel supply, and an awareness that there were still more survivors at risk.

When the basket was at the cabin door, the Flight Mechanic did not have ready access to a tool capable of cutting the survival suit to drain the water or any safety strap or harness to use to secure the survivor.

When the Flight Mechanic began to hoist Crew Member A, the Rescue Swimmer began swimming to the next survivor. The Rescue Swimmer did not maintain eye contact with the basket, as required in Commandant Instruction 3710.4B, the Coast Guard Rescue Swimmer Manual.

Crew Member A was alive when the HH-65 attempted to rescue him. Because an autopsy was not conducted, it is unknown whether the fall caused any injuries. In addition, the MBI could not determine if Crew Member A would have survived the exposure and conditions he had endured while in the water.

The Count

The HH-60 made two separate sorties to recover survivors from the ALASKA RANGER. It recovered 12 survivors on the first sortie and four survivors and the Rescue Swimmer from the HH-65 during the second.

At the conclusion of the first sortie, the Aircraft Commander, who had counted the number of survivors recovered by recording tick marks on his knee board, said to the crew, "I have 13 people. Will you confirm that, please?" According to the Aircraft Commander, the Flight Mechanic and Rescue Swimmer also counted 13 survivors. At approximately 0606, the HH-60 reported this information to CGC MUNRO Operations Center, which passed it to D17.

Due to the weight of the HH-60 and the load capacity of the CGC MUNRO flight deck, an HH-60 is not able to land on the CGC MUNRO. The survivors were hoisted down to CGC MUNRO, then the HH-60 was refueled while it hovered astern.

The HH-60 reached the CGC MUNRO and commenced lowering survivors at approximately 0644. As each survivor was lowered, he was assisted to the mess deck by two CGC MUNRO crew members, where others were waiting to provide additional assistance.

During this hoist evolution, the HH-60 did not count the survivors as they were lowered. Personnel on the bridge of the CGC MUNRO counted the survivors as they were lowered to the deck and were in radio contact with the HH-60, but not the CGC MUNRO's Operations Center. When the final survivor was transferred, the Flight Safety Officer reported to the bridge that only 12 survivors, not 13, had been lowered. As the CGC MUNRO changed its focus to the inflight refueling, no one on the bridge notified the CGC MUNRO Operations Center or D17 of the discrepancy.

Before the in-flight refueling of the HH-60 was completed, the HH-65, en route to the CGC MUNRO, declared it was fuel critical and requested CGC MUNRO make best speed to rendezvous with it. The inflight refueling with the HH-60 was halted and the CGC MUNRO sped toward the HH-65 to close the distance between them.

The CGC MUNRO did not have a standard operating procedure requiring positive communications between the bridge and the Operations Center to confirm the results of hoisting operations. The Operations Center would not learn of the discrepancy in the number of survivors reported on board CGC MUNRO until D17 collected the names of the crew members from the CGC MUNRO and the ALASKA WARRIOR and determined the Fish Master was missing. More effective communications between the bridge and the Operations Center, with follow on communications from the Operations Center to D17, would have prevented the premature suspension of the search for the missing crew member.

It is unknown what happened to the Fish Master. Before the search was initially suspended, the HH-60, HH-65, and ALASKA WARRIOR found and recovered the other 46 people from the ship, including four that were deceased. Most witnesses last saw the Fish Master in the pilot house with his survival suit only halfway up. However, two of the Japanese survivors testified he abandoned ship when they did. These two both made it to a liferaft, but the Fish Master did not.

“Fish Processing Vessel” – Unclear Definitions & Enforcement Challenges

The Commercial Fishing Industry Vessel Act was passed in 1984, which amended Subtitle II of Title 46 United States Code, providing new definitions for fishing vessels, fish processing vessels, and fish tender vessels. It defined “fish processing vessel” as “a vessel that commercially prepares fish or fish products other than by gutting, decapitating, gilling, skinning, shucking, icing, freezing or brine chilling.”

The distinction between a fishing vessel and a fish processing vessel is significant. Because fish processing vessels typically have more individuals on board, more complicated working environments in terms of machinery arrangements and vessel configurations, and higher fire loads due to packaging and refrigerants, regulations require additional safety considerations primarily focused on the vessel design, construction, maintenance, stability, and watertight integrity.

As defined above, fish processing vessels greater than 5,000 GT are required to be inspected by the USCG. Per 46 CFR Part 28, Subpart F, “Fish Processing Vessel,” those not more than 5,000 GT must be: 1) examined at least once every two years by the ABS, a similarly qualified organization, or a surveyor of an accepted organization to ensure compliance with the regulations in 46 CFR Subchapter C, “Uninspected Vessels,” and 2) classed by the ABS or a similarly qualified organization if the vessel was built or underwent a major conversion after 27 July 1990. In addition, 46 CFR Subchapter E, “Load Lines,” requires fish processing vessels greater than 79 feet and built or converted after 01 January 1983 to obtain a load line.

There was significant confusion regarding the statutory definition when the USCG and fishing vessel industry began to apply them in 1985. Much of this confusion remains today. As early as May 1985, industry began seeking clarification regarding proper application of the “fishing vessel” and “fish processing vessel” definitions. On 9 May 1985, the Commandant determined that “the freezing process approximates icing” and did not constitute processing.

In addition, the Commandant also determined that a vessel that froze its catch in wax cartons and sold it for further processing was not considered a fish processing vessel. This reference to packaging was based on an element of the Congressional Record that has been interpreted broadly when differentiating between fish processing vessels and fishing vessels: “These definitions have been carefully drafted so that “fish processing vessel” is meant to only include those vessels on which extensive processing work is done to prepare either fish or fish products for marketing (emphasis added) and not vessels on which incidental or minimal processing takes place as a necessary part of the fishing activity to preserve the quality of the fish.” (130 Cong. Rec. H7230 (daily ed. June 27, 1984, page 19340), statement of Senator Gorton.)

In 1986, the definition of “fish processing vessel” in 46 USC 2101 was modified and “freezing” was added to the seven original activities considered to be incidental or minimal processing and a necessary part of the fishing activity to preserve the quality of the fish.

By 1987, naval architects and vessel designers were asking the USCG to provide interpretations and establish criteria for differentiating between fish processing vessels and fishing vessels. At this time approximately two dozen Offshore Supply Vessels were undergoing conversions to “Factory Trawlers,” as was done with ALASKA RANGER, and Jensen Maritime Consultants Inc. asked if a vessel that filleted fish, which would require additional processing and packaging ashore, would be considered a fish processing vessel and require a load line. The USCG’s reply affirmed that “sufficient preparation of the fish, including skinning, filleting, boxing, and freezing, is done on board such that the vessel falls under the statutory definition of a fish processing vessel” and a load line was required.

The USCG then denied an appeal from the Arctic Alaska Fisheries Corporation in January 1989 and upheld an OCMI decision requiring the U.S. ENTERPRISE to obtain a load line. The owner argued that although the vessel did process, it also caught fish and was consequently still a “fishing vessel” and exempt from load line requirements. After the denial, Congressman John Miller (R-Seattle) wrote to the USCG Commandant expressing his concern. He stated he was involved in developing the Commercial Fishing Industry Vessel Act of 1988 and believed the USCG was misapplying the load line requirements. “I believe Congressional intent and the language of recent legislation are clear. The U.S. ENTERPRISE should not be required to obtain a load line.” The USCG upheld its decision and detained the vessel on 19 April 1990 for failure to have a load line.

The MBI investigating the sinking of the ALEUTIAN ENTERPRISE on 22 March 1990 revealed that a significant number of fish processing vessels were operating without load lines. In a message sent to the Commandant less than one month after the casualty, the MBI acknowledged the additional safety provided by compliance with the load line requirements: “While it is premature to reach a conclusion as to whether or not the failure of the ALEUTIAN ENTERPRISE to have a load line contributed to the loss of life – it is fair to say that a load line would have provided a greater margin of safety for the vessel and its crew.”

The MBI for the ALEUTIAN ENTERPRISE subsequently recommended the USCG initiate swift enforcement action to bring fishing industry vessels into compliance with load line requirements and advised: “It is critical that we continue to apply safety statutes and regulations

to the trawler/processor fleet very broadly to give processor personnel and the remainder of the crew the highest margin of safety possible within our limited authority over this industry.”

Adopting the recommendations of the Commandant, MSO Puget Sound launched the “Interim Enforcement Program for Fish Catcher-Processor Vessels” in July of 1990. The comprehensive program included detailed forms and instructions and clearly delineated roles and responsibilities of the vessel owner, naval architect, and OCMI. Each owner was required to submit a letter to the OCMI attesting that the vessel “substantially meets applicable stability criteria, that suitable stability guidance is provided to the Master, and the Master is qualified in the use of the stability guidance.” An initial Classification Society survey was conducted to determine: 1) if the vessel’s actual configuration was properly reflected in the stability calculations and guidance provided to the Master, 2) the integrity of the assumed watertight and weathertight envelope, 3) the degree to which the vessel meets the conditions for load line assignment, and 4) whether or not minimum lifesaving, fire fighting and EPIRB requirements were satisfied. If satisfied the vessel could safely operate in the interim, the owner was allowed to continue processing and provided time to obtain compliance.

Implementing the Interim Enforcement program was difficult. Each vessel owner had to determine whether his or her vessel was a fishing vessel or a fish processing vessel, but there was no simple way for the fishing industry or the USCG to make the determination. In many cases, a vessel might operate as a fish processing vessel on one voyage and only a fish catcher on the next, depending on the species that was being targeted and what it did with the ancillary products. The initial determination did not consider ancillary products, such as stomachs and roe, or whether the tail was also cut off the fish before freezing.

MSO Seattle, MSO Anchorage, D13, D17, and USCG Headquarters were then asked a series of questions by industry regarding interpretations of the definitions and the differences between fishing vessels and fish processing vessels. On 20 June 1990, the Commandant provided clarification of the fish processing vessel definition. The detailed three page policy memo contained the following summary:

“The definition is very specific. Strict interpretations of the definition should be applied. Any fishing vessel that prepares its or another vessel’s catch in a manner that exceeds gutting, decapitating, gilling, skinning, shucking, icing, freezing, or brine chilling is considered a fish processing vessel.”

The simple, concise and direct verbiage was followed with a brief discussion of individual “exceptions” that may be applied at the OCMI’s discretion. That discussion stated:

“Any exceptions shall be evaluated and addressed by OCMI’s on a case-by-case basis. An exception might include some minimal preparation, not listed in the law that is part of one of the preparation processes listed in 46 USC 2101(11b).”

The interpretation of these exceptions has been the source of considerable confusion to the USCG and fishing vessel industry. Compounding the confusion was the fact that five different entities were evaluating and addressing exceptions, making the load line enforcement program

more complicated and difficult. In an email to the District 13 Marine Safety staff on 16 May 1991, the Chief of Inspections at MSO Puget Sound wrote, "I think one of the Districts should have been coordinating the load line enforcement initiatives (sic) from the beginning. I agree w/ D17; taking and processing roe is "processing". Sure, its (sic) no more processing than heading, gutting, etc on a large factory vessel, but the latter should also be considered processors and its time we get the law changed."

In June 1991, MSO Puget Sound sent a letter to USCG Headquarters that echoed this frustration stating, "We are constantly making interpretations relative to the definitions, many of which defy logic." The letter closes with "Lastly, reference (a) noted JMC's suggestion that the definitions of fishing industry vessels be reviewed, but indicated that they "cannot easily be changed." They certainly won't get changed if no one takes the initiative to do so. I concur with JMC, that this is the right time to move for statutory changes, particularly those discussed above. I believe we can reduce the long-term workload in the field, with an overall savings to the Coast Guard, if we put forth the short term effort to get these changes made now while the public and industry, in general, strongly support safety improvements. More importantly, these changes should improve safety in the industry. With a phased in approach, but not a grandfather, the economic impact on the industry can be minimized."

Approximately 100 fish processing vessels eventually obtained compliance and were issued Load Line Certificates and Certificates of Compliance. If owners did not enroll their vessels and were found processing at sea, they faced detention and civil penalty action. In at least one case, civil penalty action was pursued. American Empire LTD Partnership was assessed a \$2500 fine in February of 1994 for "operating a vessel without an assigned load line."

The USCG focus on enforcement of load line regulations on fish processing vessels waned in the mid 90's. There was no reliable, active program with dedicated resources in place to ensure vessels remained in compliance. At sea boardings were rare, and boarding officers were not likely to have the experience or expertise to clearly distinguish between "head and gut" operations and fish processing.

Replacement Vessels

Under current law and regulation, owners of vessels in the "head and gut" (H&G) fleet that operate in the Bering Sea and Gulf of Alaska cannot replace an existing vessel brought into service prior to the implementation of the CFVS Act and its implementing regulations, with a comparably sized vessel that meets current safety regulations.

When the Commercial Fishing Industry Vessel Safety Act of 1988 was passed, the intent was to regulate a "... class of vessels covered by the bill are new vessels, built after December 31, 1988, and that normally operate with crews of more than 16. These vessels are the largest in our fleets and will be subject to the most stringent safety requirements, such as proper radars, life saving and firefighting equipment, ventilation and electrical systems as well as bilge pumps and alarms." (134 Cong Rec H 4729 (daily ed. June 27, 1988), statement of Congressman Studds.)

Yet, when the American Fisheries Act of 1998 (AFA) created two fleets of vessels, the AFA fleet and the non-AFA fleet, it only allowed for replacement of vessels in the AFA fleet that are lost under certain circumstances. It did not address whether non-AFA vessels could be replaced. Within the Bering Sea/Aleutian Island management area, fishing vessels are divided into four subsectors: non AFA catcher/processor⁴ vessels, non-AFA catcher⁵ vessels, AFA catcher/processor vessels, and AFA catcher vessels.

The ALASKA RANGER and the other vessels in ACSA fall within the non-AFA catcher/processor vessel subsector.

On 14 September 2007, NMFS published a Final Rule (Federal Register, September 14, 2007, page 52667-52743 (Volume 72, Number 178)) implementing a capacity reduction program for the Bering Sea/Aleutian Island non-AFA catcher processor subsector. As part of this capacity reduction program, NMFS purposely did not incorporate provisions for replacing vessels in the non-AFA trawl catcher processor subsector.

NMFS' decision to refuse to allow an owner to replace a lost vessel was challenged in court (Arctic Sole Seafoods v. Gutierrez, 622 F.Supp.2d 1050 (W.D.Wash. 2008)), and the court found that the regulations were not in accordance with law where they prevented an owner from replacing a vessel that had been lost. The court set aside the regulations where the regulations did not allow an owner to replace a vessel that had sunk, and remanded the regulations to NMFS for further action. While the court decision may allow for an owner to replace a vessel that is lost, it does not require NMFS to amend the regulations to allow an owner to replace a vessel due to its age or condition.

ACSA Program

Background

The H&G fleet that operates in the Bering Sea and Gulf of Alaska consists of the freezer longliners and freezer trawlers. With the ability to store frozen catch on board, H&G vessels are able to operate in the most remote areas of the Bering Sea, far from search and rescue support, making the seaworthiness of the vessel of even greater importance for protecting the crew.

The H&G fleet differs from typical commercial fishing vessels that generally deliver fish whole in that they have a factory space where fish are sorted, eviscerated, cleaned and prepared into various products, which are then frozen, packaged, and stored on the vessel for later delivery. A typical fishing vessel operates with only 5 or 6 crew members, while H&G vessels need

⁴ For the purposes of the ground fisheries, a catcher/processor is a vessel that is used for catching fish and processing that fish. See 50 CFR 679.2 for more detail.

⁵ For the purposes of the ground fisheries, a catcher vessel is one that is used for catching fish and that does not process fish on board. See 50 CFR 679.2 for more detail.

additional personnel to work in the factory and normally have a crew complement ranging from 15 to 55 people. The investigations into two casualties involving H&G vessels, the loss of the ARCTIC ROSE and a fire aboard the GALAXY, highlighted important safety issues within the H&G fleet.

The ARCTIC ROSE capsized in 2001 with 15 fatalities. The subsequent USCG investigation determined the vessel was a fish processor operating without a load line and certificate of compliance and it was not classed by ABS or another qualified organization. One resulting recommendation was that the USCG should seek a legislative change to remove the existing grandfather provisions and require all fishing vessels and fish processing vessels over 79' in length to meet the stability requirements in 46 CFR 28 Subpart E, or remove the exemption for fishing vessels in 46 CFR Subchapter E and require load line assignment.

While the Commandant concurred with the intent of the recommendation, and agreed compliance would improve the safety of existing fishing vessels, the endorsement went on to state that a "voluntary compliance program" would be more appropriate and influential than implementation of additional regulatory requirements.

The investigation also recommended that the installation of alarms on watertight and weathertight doors and high water alarms in factory spaces be required. Again, the Commandant concurred with the intent, but stated a voluntary compliance program was more appropriate than regulations.

Another recommendation was for the USCG to re-evaluate the regulatory definition of fish processing vessels to ensure it included head and gut operations. The Commandant stated the definition of a fish processing vessel in law and regulation would be reviewed and action would be initiated to amend it to ensure it included vessels that conduct head and gut operations.

In 2002, another fish processing vessel, the F/V GALAXY, experienced a fire, explosion and sinking, resulting in the loss of 3 people. The vessel was classed by ABS and had a valid load line certificate and certificate of compliance, but the casualty investigation revealed that many other vessels in the H&G fleet were operating as fish processing vessels and did not meet these same requirements. In addition, deficiencies in stability, watertight integrity, and crew training were found to be prevalent on many vessels in the H&G fleet.

The F/V GALAXY investigation recommended the USCG seek legislative authority to define a "head and gut fish processing vessel" in 46 USC 2101(11) to include vessels engaged in H&G processing operations with more than 16 people on board. The Commandant agreed and stated a legislative or regulatory proposal would be initiated to define and classify these vessels based on the number of persons on board.

However, to date, no regulatory or legislative changes have been made to the definition.

Clarification of the Definition of Fish Processing Vessel

No regulatory or legislative changes were made to the definitions. In 2006, D13 and D17 created the ACSA program, which removed some of the ambiguity regarding what constituted fish processing. It evaluated and classified each product produced by the H&G fleet and regularly reported to NMFS using standard product and delivery codes (50 CFR Part 679, Table 1). The agreement placed each product into one of three categories based on the extent of processing necessary to produce it.

- 1) “H&G Products” were produced by “minimal processing which is a necessary part of the fishing activity.” None of these products are produced from fish processing activities. ACSA stated that vessels that produced these products were not fish processing vessels and not required to meet ACSA requirements.
- 2) “Products Exceeding Minimal Processing” were produced with activity exceeding the standard of minimal processing, but did not meet the standard of “extensive processing” established by the Congressional Record. Many H&G vessels that were considered fishing vessels produced these products. According to the ACSA Agreement, most of the products were ancillary, but were likely important to the fleet in order to meet by-catch regulations. The nine products produced in this manner were described by NMFS product and delivery codes as: headed and gutted with tail removed, kirimi, roe, pectoral girdles, heads, cheeks, chins, milt, and stomachs. ACSA stated that any vessel that produced one or more of these products was a “fish processing vessel.” H&G vessels that produced these products could enroll in ACSA in lieu of meeting class and load line requirements. Alternatively, operators could opt to cease production of those nine fish products that are considered “Products Exceeding Minimal Processing.”
- 3) “Extensive Processing” included those products that were produced by fish processing vessels by means other than “gutting, decapitating, gilling, skinning, shucking, icing, freezing, or brine chilling.” These products could only be produced by fish processing vessels that complied with 46 CFR 28 Subpart F and were classed and load lined. Vessels enrolled in ACSA were not authorized to produce these products.

ACSA Policy Documents

The USCG issued three documents when it initiated ACSA.

1. Commandant (G-PCV) Policy Letter 06-03, “Exemption Letter for Existing Fish Processing Vessels,” dated 1 July 2006, provides guidance for the issuance of exemption letters to existing fish processing vessels for which exemption applications which were received by 15 July 2006. District Commanders and OCMI were required to ensure these guidelines were considered prior to granting exemptions to existing fish processing vessels, but the guidance was “intended to provide sufficient flexibility to accommodate vessel differences and support local judgment.” On 22 August 2006, the USCG published a Federal Register notice entitled “Head and Gut Fleet; Alternate Standards for Fish Processing Vessels” announcing the availability of Commandant (G-PCV) Policy Letter 06-03.

2. "Alternate Compliance and Safety Agreement (ACSA) for the Bering Sea/Aleutian Island and Gulf of Alaska Freezer Longliner and Freezer Trawler Fishing Fleets," (ACSA Agreement), dated 15 June 2006, preceded the Commandant policy by two weeks. It was signed by the Commanders of the Thirteenth and Seventeenth Coast Guard Districts and stated it would resolve current shortcomings in the safety regime of the H & G fleet by implementing the recommendations from the ARCTIC ROSE and GALAXY investigations to resolve the long-standing issue over the distinction between "H&G" and "fish processing."
3. "Alternate Compliance and Safety Agreement (ACSA) for Fish Processing Vessels," D13 Instruction 16710.1, dated 15 June 2006, was promulgated by the Commander, Thirteenth Coast Guard District. The purpose of this document was to provide background and implementing guidance for the ACSA Agreement. This document contained five enclosures that were to be used to implement ACSA.

The safety measures contained within the ACSA Agreement and the D13 instruction were developed during 2005 and 2006 by representatives from MSO Puget Sound (now Sector Seattle), MSO Anchorage (now Sector Anchorage), commercial fishing vessel safety (CFVS) coordinators from D13 and D17, and members of the fishing vessel industry. The Program Manager for the USCG CFVS Program at CGHQ reviewed the measures prior to their release.

Premise Behind the Program

The authors of ACSA determined that H&G vessels that exceed "minimal processing", but do not conduct "extensive processing", are fish processing vessels. The ACSA program was created with the intent of improving the safety of these vessels by providing a level of safety considered equivalent to that afforded by compliance with the requirements for classification and load line. These vessels were eligible to enroll in ACSA in lieu of meeting existing legislative and regulatory requirements for fish processing vessels.

As justification for this standard, ACSA stated that 67% of the H&G fleet exceeded the vessel age restrictions imposed by class and were ineligible for classification and load line. It claimed DNV and ABS "have policies that a non-classed fishing vessel greater than 20 years old cannot be classed" and "bringing vessels into classification or load line is virtually impossible." It also stated that if forced to comply with regulations for fish processing vessels, H&G vessels would opt to limit production to products requiring minimal processing rather than comply with class and load line requirements and the opportunity to improve safety on these vessels would be lost.

Evidence obtained by the MBI contradicts the assertions that the vessels could not be classed or obtain load lines. When the Agreement was being developed, DNV stated it did not have an age restriction and would class a vessel of any age. DNV also stated it would issue a load line to DNV classed vessels. When ACSA was created, ABS stated it would not class an existing fishing vessel over 20 years of age, but would issue a load line to any fish processing vessel that satisfied the load line requirements, regardless of the vessel's age. Correspondence from ABS to

the MBI stated their current policy, revised since the loss of the ALASKA RANGER, does not allow them to bring existing fishing vessels into class if they are already over 10 years of age.

Exemption Justification

As the basis for exemption from the classification requirements, the ACSA Agreement cited 46 CFR 28.60, "Exemption Letter." This regulation gives the District Commander authority to grant exemptions for requirements in 46 CFR Part 28 provided: 1) "good cause" exists for the exemption; and 2) the safety of the vessel and those on board will not be adversely affected.

The Commandant Policy Letter encouraged the District Commander to exercise discretion in issuing exemptions. It stated each vessel owner had the burden of showing good cause and adequate levels of safety, and a request for exemption should be accompanied by documentation articulating why "good cause" exists. It also stated the request should explain why the owner was not pursuing examination and classification, and demonstrate how the owner proposed to provide a level of safety equivalent to that required by classification and load line assignment. Lastly, the Policy Letter stated the District Commander should consider whether the vessel's seaworthiness was comparable to that of vessels examined and classed under Subpart F.

These recommendations were not followed. The ACSA applicants were not required to provide "good cause" or justification for their exemptions. Similarly, vessel owners were not required to explain why they were unable to comply with load line or classification requirements before receiving exemptions. The ACSA Agreement cited the inability of H&G vessels to comply with load line and class society requirements, associated fishery management issues, and the USCG's goal of improving safety as "good cause" for exemptions. It also stated the safety of the vessel and those on board would not be adversely affected because "ACSA would significantly improve the safety regime for this fleet." Finally, the D13 instruction stated the ACSA Agreement "fully documents that both criteria for exemption have been met for this fleet of vessels."

The ACSA Agreement then cited 46 USC 5108(a)(2) as the basis for exemptions to the load line requirements, but did not clearly state which specific load line requirements could be exempted and who would issue the exemption. The Policy Letter, in turn, stated the OCMI could grant a Load Line Exemption Certificate to coincide with the District Commander's exemption from the survey and class requirements in 46 CFR Part 28, Subpart F, "Fish Processing Vessel."

There was disagreement among different USCG offices regarding the intent of the load line exemption and the implementation process. The D13 CFVS Coordinator and Sector Seattle CFVS Examiner believed all vessels enrolled in ACSA would be exempted from all requirements to obtain a load line. In contrast, personnel at Sector Anchorage believed ACSA enrollment did not entitle a vessel to a "blanket" exemption from all load line requirements. Sector Anchorage believed a load line exemption certificate documenting those specific load line requirements that were exempted would be issued by the OCMI and remain valid for two years, at which time the vessel would be re-examined to determine if the exemptions would be renewed. Sector Anchorage expected each vessel's condition to improve over time and the degree of compliance to increase, perhaps eventually eliminating the need for exemptions.

ACSA Application Timeline

Each vessel owner seeking to enroll his vessel into ACSA was required to file an application no later than 15 July 2006. Each vessel was to receive an initial USCG examination no later than 1 May 2007 to assess its compliance with the ACSA standards and provide each owner with a worklist identifying deficiencies and required compliance dates. By 1 June 2007, each vessel was required to have a stability addendum. By 1 January 2008, each vessel was required to receive satisfactory USCG dry dock and internal structural examinations and clear all outstanding worklist items identified during the inspections.

If the vessel owner was making a “good faith effort” to correct deficiencies identified by the USCG, Sector Seattle or Anchorage was required to issue a letter no later than 1 June 2007 authorizing “interim enrollment” into ACSA. Following 1 May 2007, owners of vessels producing fish products identified as beyond minimal processing who had not demonstrated a good faith effort to come into compliance were subject to civil and/or criminal penalties and operational controls.

Due to differences concerning the intent and implementation of ACSA, members from both Sectors and Districts met on 15 and 16 January 2008, two weeks after the deadline for ACSA implementation and compliance had passed. Sector Anchorage outlined their concerns in a document on or about 21 January 2008. The following items were included:

- The qualifications required for the attending USCG personnel were not specified in the Policy Letter or ACSA Agreement. Sector Anchorage believed only Marine Inspectors with Hull, Machinery and Drydock qualifications were capable of conducting the exams. Sector Anchorage had only one marine inspector with these qualifications, and MSD Dutch Harbor had none.
- Vessels enrolled in ACSA were leaving drydock with excessive structural deficiencies. Although most of the work can be identified during internal exams before going to drydock, Sector Anchorage believed vessel owners were not adequately evaluating their vessels and scheduling enough time in drydock. Sector Anchorage stated, “these are not isolated incidents,” suggesting a systemic problem with the implementation of ACSA requirements.
- Most vessels had drydock exams before their stability addendums were complete. Sector Anchorage believed it was critical to have the addendums completed by a naval architect prior to conducting the drydock exam. To illustrate their point, Sector Anchorage described an incident where they attended a vessel in Dutch Harbor and found it had “no true watertight envelope and had undergone many conversions.” They believed most of the naval architects completing the stability calculations and addendums were not attending the vessels to ensure their assumptions were accurate. Sector Anchorage recommended that drydock exams not be conducted unless the addendum was complete and available to the attending MI.
- Sector Anchorage was concerned that some ACSA vessels did not have adequate structural fire protection surrounding their machinery space. Although Sector Seattle indicated they were requiring A-class boundaries, Sector Anchorage found no requirement in ACSA.

While several items were addressed during the meeting, no resolution was reached concerning the issuance of the exemptions.

In an attempt to resolve the impasse, the USCG Headquarters CFVS Program Manager convened a conference call on 29 January 2008 with Sector Seattle, Sector Anchorage, D13, and D17. The OCMI for Western Alaska stated he was willing to issue load line exemption certificates, but was not prepared to entirely exempt a vessel from the requirement to obtain a load line and questioned whether he even had the authority to do so. The CFVS Program Manager verbally instructed D13 and D17 to deviate from the Policy Letter and exempt fish processing vessels enrolled in ACSA from the requirement to obtain a load line. Shortly afterward, an unsigned draft copy of a revised Policy Letter, which directed the District Commander to exercise the authority provided in 46 CFR 28.60 and issue exemptions from the requirement to maintain a load line certificate, was forwarded with an e-mail indicating it was awaiting clearance and final approval. The MBI found no evidence that the revised Policy Letter was ever signed and promulgated.

In late February 2008, almost 2 months after the deadline for full compliance had passed, the USCG did not know the compliance status of the vessels that had applied for enrollment into ACSA. D13 sent a letter on 28 February 2008 to all applicants requesting they update the USCG on their status and propose a schedule for compliance. The letter also provided a blanket extension until 28 March 2008. Until this time, it does not appear there was any organized effort by the USCG to track progress or determine the status of vessels with outstanding worklist items.

On 26 March 2008, three days after the loss of the ALASKA RANGER, the D13 Chief of Prevention issued exemption letters to 12 vessels. Each of these vessels had enrolled in ACSA in July 2006 and the majority of them were found to be in compliance with all ACSA requirements by the end of July 2007, but they waited from 3 to 15 months to receive their exemption letter.

ACSA Enrollment Process and the ALASKA RANGER

The following is a brief summary of ACSA enrollment deadlines.

15 July 2006	Deadline for enrollment applications. Vessels producing products without an application on file are subject to penalties and operational controls.
15 September 2006	Deadline for scheduling a preliminary exam with Sector Seattle or Anchorage to verify vessel progress in obtaining compliance with ACSA.
1 May 2007	Deadline for completing preliminary exams. Deficiencies are to be identified and listed on a worklist with specific completion dates.
1 June 2007	Deadline for providing “interim enrollment” into ACSA for vessel owners making a “good faith effort” to correct deficiencies.
1 June 2007	Deadline for preparing the stability addendum specified in enclosure (3) to the ACSA Agreement.
1 Jan 2008	Per the Policy Letter, full compliance with all requirements and issuance of exemption letters and Load Line Exemption Certificates should be

	<p>completed. According to the ACSA Agreement, deadline for completing all worklist items. However, OCMI's were authorized to issue waivers for meeting the "full compliance deadline" on a case-by-case basis. Similarly, the D13 Instruction authorized the OCMI to grant extensions that "should not exceed 180 days."</p>
--	---

Figure 34: Summary of ACSA Enrollment Deadlines

The ALASKA RANGER consistently produced NMFS product codes 10 and 14, “Headed & gutted, Tail Removed” and “Roe” respectively, which are both defined as “Exceeding Minimal Processing.” As shown in Figure 35, products defined by ACSA as “Exceeding Minimal Processing” have accounted for less than 1% of the total annual product produced on the ALASKA RANGER since 2002. However, in order to continue producing these products, the ALASKA RANGER had to enroll into ACSA or meet classification and load line requirements.

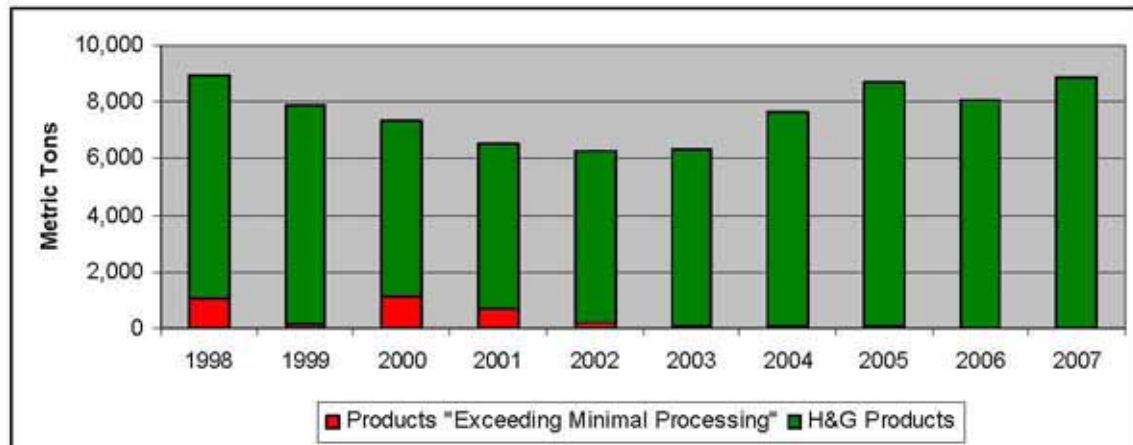

Figure 35: ALASKA RANGER Catch Sorted by ACSA Product Code

The application requirements in the ACSA Agreement were not followed for the ALASKA RANGER. On 5 April 2006, more than 10 weeks before the issuance of the ACSA Agreement and D13 Instruction, FCA submitted an application to enroll the ALASKA RANGER and six other vessels into ACSA. In a letter sent 22 months later, D13 told FCA the application for exemption from the requirements to be classed by the ABS or a similarly qualified organization and the load line requirements “constituted acknowledgement that the subject vessel operates as a fish processing vessel as defined in 46 CFR Part 28.”

Information provided by FCA to the USCG on the ACSA application for the ALASKA RANGER was incomplete and incorrect. In response to the question “Has vessel ever been classed?”, the response appeared to be “Yes”, but the date of the last survey was left blank. In response to the question “Has vessel ever been load lined?”, the response appears to have been “No.” However, in response to the subsequent question “If Yes, when was last survey conducted & by whom?”, the response was “Expired 10-31-1995 ABS.” The reply to “When was vessel most recently drydocked?” was also left blank.

Item	Information to be Provided by Applicant	Date
		4-5-2006
1	Vessel Name	ALASKA RANGER
2	Official Number	SSO 13B
3	Has vessel ever been classed? If Yes, when was last survey conducted & by whom?	Yes / <input checked="" type="radio"/> No
4	Has vessel ever been loadlined? If Yes, when was last survey conducted & by whom?	<input checked="" type="radio"/> Yes / No EXPIRED 10-31-1995 ABS
5	When was vessel most recently drydocked?	
6	Provide Copy of Vessel's Most Current HAACP Plan	N/A
7	Provide Copy of Vessel's Most Current Stability Booklet	N/A
8		
9		
10		

Figure 36: Excerpt from ACSA enrollment application for the ALASKA RANGER

On 14 July 2006, Sector Seattle asked FCA to provide additional information so the review of the ALASKA RANGER enrollment application could be completed. However, the additional information requested did not include information regarding previous major conversions, drydock records, or stability information, all of which is required on the ACSA application contained in the ACSA Agreement. The MBI was unable to find evidence that FCA supplied the additional information.

The ALASKA RANGER received its preliminary ACSA exam on 20 June 2006, more than nine months before the deadline.

The ALASKA RANGER did not receive a letter authorizing interim enrollment by the 1 June 2007 deadline.

The ALASKA RANGER did not meet the 1 June 2007 deadline for preparing a stability addendum. FCA did not approach EBDG and request a cost estimate for completing the stability addendum for the ALASKA RANGER until 13 February 2008, almost 19 months after they were first issued a deficiency requiring it be completed, more than eight months after the deadline for completion had passed, and 44 days after the 1 January 2008 deadline for being in full compliance with ACSA.

The ALASKA RANGER never achieved full compliance with ACSA and was never fully enrolled in the program. It underwent the drydock and internal structural examination in November 2007 and received a worklist of outstanding requirements to complete. The worklist items did not have completion dates.

On 28 February 2008, D13 sent FCA a letter asking for the compliance status for each of the vessels enrolled in ACSA and granted a 30-day exemption from class and load line requirements. On 16 March 2008, FCA replied, stating the ALASKA RANGER was still not in compliance with the following nine requirements.

	Description	FCA's Proposed Completion Date
1	Provide 2-way communications from each fixed fire pull station and the pilot house.	July 2008
2	Replace Halon activation bottles in engine room.	July 2008
3	Update fire control plan.	July 2008
4	Naval architect to calculate and provide stability addendum to stability book identifying all water/weather tight doors & openings; all sea valves; and calculations for dewatering sump pumps in the factory area. Naval architect to calculate the location of waterline mark. Repaint waterline after position is calculated	Aug 2008
5	Free P/S engine room intake covers.	July 2008
6	Remove cam lock fitting on #3 Port fuel tank cover in factory.	July 2008
7	Install visual and audio indicators in wheelhouse for factory high water alarms.	July 2008
8	Repair bulkhead separating P/S aft ballast tanks.	Sept 2008
9	Install flame arrestor bowls for all MDE, generators and Bow Thruster room RACORS	June 2008

Figure 37: ALASKA RANGER's remaining ACSA worklist items, as reported by FCA

The vessel sank before D13 responded. Though at the time of the MBI hearing other FCA vessels were still not in full compliance and their 30-day exemption had expired, the Operations Manager testified, "Nobody has told us to stop fishing, and I -- we are in compliance with that program, as far as it goes. Nobody has come back and said this timeline for completion is unacceptable. So I fully expect we will receive the further extension."

ACSA Inspection Requirements and the ALASKA RANGER

The intent of this section is to evaluate the application of the ACSA requirements to the ALASKA RANGER. In addition, it highlights some differences between ACSA and class and loadline requirements.

The general areas addressed by ACSA, listed in enclosure (3) to the ACSA Agreement, are:

- A. Compliance,
- B. Vessel Stability,

- C. Drydock and Internal Structural Examination,
- D. Tail Shaft Examinations,
- E. Hull Audio Gauging,
- F. Watertight and Weathertight Closures,
- G. Machinery Maintenance, Inspection, and Testing,
- H. Life Saving Equipment and Arrangements,
- I. Fixed Fire Fighting Equipment and Arrangements,
- J. Other Fire Fighting Equipment and Fire Fighting Plans,
- K. Emergency Drills and Training, and
- L. Emergency Communications and Navigation

By contrast, had the ALASKA RANGER been classed by ABS, it would have been subject to the requirements in the ABS “Rules for Building and Classing Steel Vessels Under 90 Meters” (ABS Rules). Vessel drawings, specifications, and calculations would have been reviewed by ABS to confirm compliance prior to being classed. In addition, the ALASKA RANGER would have received Annual Surveys, Intermediate Surveys at or between the second or third Annual Surveys, and Special Periodical Surveys every five years to verify continued compliance. Similarly, in order to have a load line certificate the ALASKA RANGER would have received annual load line surveys.

Stability and Watertight Integrity

The ACSA Agreement contains the following stability and watertight integrity requirements:

- **Stability Instructions:** The stability instructions shall comply with 46 CFR 28.530, “Stability instructions,” and identify the maximum draft mark at amidships. Permanent fore and aft draft marks are required.
 - At the time of the casualty, the ALASKA RANGER had stability instructions, but did not have a maximum draft or draft marks assigned. It was not in compliance.
- **Inclining Experiment:** At the time of enrollment, the vessel must have lightship information from an inclining experiment conducted within the last five years. Every five years, a new inclining experiment and up-to-date Stability Instructions are required, unless the validity of existing data and information can be verified via deadweight survey and inspections.
 - The ALASKA RANGER was in compliance. The vessel had received an inclining experiment on 10 June 2005.
- **Stability Addendum:** An addendum to the Stability Instructions must be provided and shall include a list of all watertight bulkheads, watertight closures, a tabulation of all weathertight closures on the main deck or above, and all through-hull valves including location, size, type and remote operators.

- The ALASKA RANGER was not in compliance. As stated in FCA's letter to the USCG on 16 March 2008, it did not have a stability addendum.
- Factory Dewatering Calculations: Factory deck sump pump calculations confirming the capacity on each side of the vessel is equal to twice the total inflow of processing water to the factory are required. If freeing ports or scuppers are used in lieu of sump pumps, the number and size of the freeing ports or drain lines shall be identified in stability addendum.
 - The ALASKA RANGER was not in compliance. As stated in FCA's letter to the USCG on 16 March 2008, the calculations were incomplete.
- Watertight Door Signage: All watertight doors through which the vessel crew may pass that are listed in the Stability Addendum shall be fitted with a sign on both sides reading "Opening authorized for transit only – keep closed at sea." Similar signs shall be posted at all weather-tight doors to buoyant volume spaces identified by the naval architect.
 - The ALASKA RANGER was not in compliance. Without a stability addendum, the crew did not know what watertight doors to mark and keep closed.
- Watertight Door Maintenance: A preventative maintenance schedule for watertight and weathertight closures is required. Written instructions shall prescribe periodic at-sea security checks to monitor the status of all watertight and weathertight closures listed in the Stability Addendum. A written log, signed daily by the master, and a ship's log entry shall record the periodic security checks.
 - The ALASKA RANGER was not in compliance. The stability addendum had not been completed, and no maintenance program had been implemented.
- Weathertight Doors: Weathertight doors located on the main deck in the aft 1/3 length of the vessel, and open to interior of the vessel, must have a coaming height of at least 24 inches, be of the "quick acting" type, and be fitted with a "door ajar" alarm to sound at the pilot conning station.
 - The ALASKA RANGER was not in compliance as the doors were not fitted with alarms.
- Factory space high water alarms shall be installed near each corner of the factory space and alarm at when the water level exceeds 6 inches. A visual indicator shall be installed in the factory and at the machinery space control flat. Visual and audio indicators shall be installed in the pilot house.
 - The ALASKA RANGER was not in compliance. This item was an outstanding deficiency on the worklist generated during the 2007 USCG drydock examination. As stated in FCAs letter to the USCG on 16 March 2008, the bridge alarm indicators had not yet been installed.

Had the ALASKA RANGER been classed by ABS, a partial listing of the survey requirements included the following:

- An annual survey of watertight bulkheads, bulkhead penetrations, and watertight and weathertight doors, including stiffening, dogs, hinges and gaskets, and confirmation of proper operation.
- Operational testing of watertight doors every five (5) years to confirm their ability to maintain tightness.

Had the ALASKA RANGER been required to maintain a Load Line Certificate, weathertight doors and closing appliances, including dogs, hinges, and gaskets would have been annually examined to confirm proper operation.

In addition to a stability assessment, a load line assignment would have required geometric calculations that considered several physical characteristics of the vessel, including its length, proportion, and block coefficient. These calculations would have been used together with the stability assessment to determine the minimum allowable freeboard and location of the load line mark, which reserves a portion of the hull's buoyancy above the waterline.

The geometric calculations may be more conservative than the stability requirements. Consequently, though a vessel may be able to satisfy all stability requirements at deeper drafts, the assigned load line may be at a lesser draft in order to satisfy the minimum freeboard determined by the geometric calculations. The load line requirements also contain minimum bow height requirements to reduce the amount of water shipped over the bow and ensure there is sufficient buoyancy at the bow to recover in the event the bow is immersed in a wave or seaway.

Drydock Examination

The ACSA Agreement included the following drydock and internal structural examination requirements:

- Drydock and Internal Structural Examination (ISE) Interval: Examinations should be conducted at least 2 times in any 5 year period with a maximum interval of 3 years between any two exams, per 46 CFR 61.20-5, "Drydock Examination"
 - The ALASKA RANGER was in substantial compliance. It underwent a USCG drydock examination in November and December 2007. Only eight of the ALASKA RANGER 's 13 integral tanks received an ISE.
- Items Examined: At each drydock examination, the hull, internal structure, propeller, stern bushing, sea connections and fastenings shall be examined. Sea chests, sea valves, sea strainers, and valves for the emergency bilge suction shall be opened up for examination every alternate drydocking.

- The ALASKA RANGER was in compliance. It underwent a USCG drydock examination in November 2007.
- Tailshafts: Examinations, inspections and tests of the tailshafts must be conducted in accordance with 46 CFR 61.20-15, “Tailshaft Examination,” and in the presence of the USCG, accepted organizations, or an accredited marine surveyor of an approved 3rd party organization. Examination intervals and requirements are the same as those required for inspected vessels. Since the ALASKA RANGER had multiple shafts, the tailshafts must be examined every five years.
 - The ALASKA RANGER was in not compliance. The tailshafts on the ALASKA RANGER were not examined, inspected or tested during the 2007 drydock, its initial examination for entry into ACSA. The Sector Seattle CFVS Examiner improperly granted an extension to ALASKA RANGER until the next drydock examination based on shaft bearing clearance readings from 2005 that were not taken in the presence of the USCG, an accepted organization, or an accredited marine surveyor.
- Repair Standards: Where guidance is needed for repairs to hull, framing, and other structural members, existing requirements for inspected vessels and “good marine practice” should be applied.
 - The ALASKA RANGER departed the shipyard in December 2007 with outstanding structural deficiencies that would not have been acceptable for an inspected vessel.

Had the ALASKA RANGER been classed by ABS, a partial listing of the survey requirements included the following:

- At each annual survey the forepeak and port and starboard aft ballast tanks would have been internally examined since the vessel was more than 15 years of age and did not have a protective coating in the ballast tanks.
- At each annual survey the structural condition of the hull would have been assessed. Suspect Areas⁶ identified in previous surveys would have received an overall and Close-up Survey⁷. At or between the second or third annual survey at least two of the fish holds would be surveyed to determine the overall condition of the hull structure.
- During each drydock survey all visible parts of the rudder and rudder shafts and their securing arrangements would have been examined. The rudder bearing clearances would have been measured and reported. If there were indications of excessive wear, damage, or

⁶ “Suspect Areas” are areas prone to rapid wastage or having Substantial Corrosion.

⁷ A “Close-up Survey” is a survey where the details of structural components are within the close visual inspection range of the Surveyor, i.e., normally within hand’s reach.

the condition was otherwise in question, the rudder would likely have been pressure tested or lifted and the bearings examined and machined or replaced every five years.

- Every five years flanged propeller shafts with water lubricated bearings would have been entirely withdrawn and the coupling bolts and flange radius examined for surface cracks.
- Every five years controllable pitch propellers would have been function tested, examined for blade seal leaks, and, if deemed necessary by the Surveyor, opened up for further examination.
- Every five years an Overall Survey would have been conducted in all double bottom, ballast, and peak tanks, machinery spaces, cofferdams and voids. The survey would have included the plating and framing, bilges, and sounding, venting, and pumping arrangements.
- Every five years an internal examination would have been conducted in at least half of all fuel oil tanks, including one in way of the engine room, one lube oil tank, and all freshwater tanks because the ALASKA RANGER was more than 15 years of age.

Had the ALASKA RANGER been required to maintain a Load Line Certificate, a partial listing of the survey requirements included the following:

- Annual examination of the watertight bulkheads, bulkhead penetrations, and end bulkheads of enclosed superstructures, as well as the operation of any installed doors.
- Annual examination of structural areas of the hull particularly susceptible to accelerated corrosion, including spaces used for salt water ballast.
- Annual visual examination of areas with substantial corrosion.

Hull Plating Thickness Gaugings

The ACSA Agreement contained the following hull plating thickness gauging requirements:

- Hull plating and main support member thickness gauging should be conducted as part of the initial consideration for exemption and at each alternate scheduled drydock thereafter.
 - The ALASKA RANGER was not in compliance. Thickness gaugings were taken on the hull plating on the ALASKA RANGER, but did not include the internal members of the fore and aft ballast tanks or the transom stern, an inaccessible void and suspect area of the hull, as specified by enclosure (3) to the ACSA Agreement.
- Wastage shall be determined by comparing the existing thickness of plating or support member to its original thickness. Wastage shall not exceed 25% of the original thickness, unless it can be shown by calculation that the wasted plate or support member continues to exceed ABS minimum standards. If the original thickness cannot be determined, the Commandant Policy Letter states the owner shall present calculations comparing existing

scantlings to the ABS Rules for Classing and Building Steel Ships; however, under the same circumstances, the ACSA Agreement requires the OCMI to make a “reasonable estimate” of the original scantlings.

- The ALASKA RANGER was not in compliance. The attending USCG marine inspectors did not have vessel drawings available and could not determine the original plating thicknesses while in the shipyard. They were not provided a gauging report that confirmed wastage did not exceed 25% or calculations demonstrating the existing plating and support members exceeded ABS minimum standards. FCA was not required to present calculations comparing the existing plating and scantlings to those required by the ABS Rules.

Had the ALASKA RANGER been classed by ABS, it would have had to comply with thickness gauging requirements very similar to those required by the ACSA Agreement. However, additional requirements of class that were not required by ACSA included:

- Substantial Corrosion⁸ identified at a previous survey would have been gauged annually to determine the remaining thickness. Where Substantial Corrosion was found, additional thickness measurements would have been taken to determine the extent of the Substantial Corrosion. If an Extensive Area of Corrosion⁹ was found, or if the surveyor considered it necessary, thickness measurements would have been carried out and renewals and/or repairs made if wastage exceeded allowable margins.
- Submission of a thickness gauging reports, which must include 1) structural member identification by frame and strake locations and a description of the structure, 2) sketches to supplement identification of the structural members, 3) original scantling or thickness of the member, 4) maximum allowable corrosion in mm/inches, 5) thickness gauging readings in mm/inches, 6) actual corrosion in mm/inches, and 7) percent corrosion of each structural member.
- An attending ABS surveyor must witness thickness gaugings to the extent necessary to confirm the company taking the measurements is competent, the measurements required by the ABS Rules have been taken, areas of substantial corrosion have been identified and additional gaugings have been taken, and areas requiring renewal have been identified.
- While the thickness gaugings are in progress, the attending ABS Surveyor is required to verify and review the preliminary results and track the progress. The purpose of this review is to verify: 1) the gaugings are being taken as directed, 2) areas of substantial

⁸ “Substantial Corrosion” is as an extent of corrosion such that assessment of the corrosion pattern indicates wastage in excess of 75% of the allowable margins but within the acceptable limits.

⁹ “Extensive Area of Corrosion” is corrosion of hard and/or loose scale, including pitting, over 70% or more of the plating in question, accompanied by evidence of thinning.

corrosion and areas of wastage that exceed the allowable limits have been identified, 3) additional gaugings, as required, are being taken, and 4) recommended repairs are addressed. The surveyor is to retain the preliminary reports and ensure the final gauging report is consistent.

- The ABS Surveyor is expected to have the maximum allowable wastage limits “readily at hand” during the survey so that additional gaugings can be requested, as necessary, for marginal conditions or questionable measurements as soon as the initial thickness measurements are known.
- If the ABS Surveyor is unable to complete the overall survey, close up survey, or thickness gaugings because he is not provided proper access, the space is not sufficiently clean, or for some other similar reason, it should be treated as an “incomplete” survey.

Had the ALASKA RANGER been required to maintain a Load Line Certificate, thickness gaugings in way of areas with substantial corrosion, as was found by the FEACT MI in the aft salt water ballast tank, would have been completed annually.

Lifesaving

The ACSA Agreement contained the following lifesaving requirements:

- All required liferafts shall be mounted such that they can be launched manually by a single person.
 - The ALASKA RANGER was in compliance. In his notes in the CG-840 book from the drydock examination, the Sector Seattle CFVS Examiner indicated the liferaft arrangements on the ALASKA RANGER were satisfactory.
- Embarkation ladders shall be installed at each required liferaft station that is five or more feet above the waterline.
 - The ALASKA RANGER was in compliance. Though the worklist generated during the drydock examination indicated the ALASKA RANGER was missing one embarkation ladder when it departed Japan in December 2007, it was not mentioned on the list of outstanding ACSA items FCA submitted to the USCG on 16 March 2008 and was likely installed before the casualty.
- Each immersion suit shall be fitted with a USCG or SOLAS approved strobe type Personal Marker Light.
 - The ALASKA RANGER was in compliance.
- Liferaft paddles shall not be made of plastic.

- The ALASKA RANGER was in compliance. In his notes in the CG-840 book from the drydock examination, the Sector Seattle CFVS Examiner indicated the vessel was in compliance.

Vessel classification and load line requirements did not contain any comparable requirements.

Emergency Preparedness, Communications and Navigation

The Policy Letter stated each ACSA vessel “should” meet the following requirements, while the ACSA Agreement specified that these requirements “shall” be satisfied:

- At least two (2) certified Fishing Vessel Drill Conductors shall be on board. The minimum number of recommended drill conductors increases as the number of individuals on board increases. For a vessel with more than 35 people on board, five (5) certified drill conductors are required.
 - At the time of the casualty, the ALASKA RANGER was in compliance.
- Non-English speaking crew members and fish processing personnel shall be familiar with their emergency responsibilities and duties.
 - Based on the testimony of the crew, the ALASKA RANGER was in compliance.
- Emergency drills and training shall be logged by the master and records shall be maintained.
 - The MBI was unable to confirm the ALASKA RANGER was in compliance. Testimony indicated drills were regularly conducted aboard the ALASKA RANGER. However, the logbook that would have recorded the performance of the drills was lost with the vessel.
- Each vessel must have clear procedures, signed by the master and chief engineer, explaining the conditions under which fixed fire extinguishing systems are to be used and the responsibilities of all involved parties. These procedures should be included in monthly drills.
 - The MBI was unable to confirm the ALASKA RANGER was in compliance. This was an outstanding worklist item when the ALASKA RANGER left drydock in December 2007, but was not mentioned on the list of outstanding ACSA items FCA submitted to the USCG on 16 March 2008.
- The Policy Letter states an independently powered communication system should be provided between the navigating station and the fixed fire extinguishing system discharge controls to allow immediate communications in an emergency. Hand held radios are permitted, if stowed at the navigating station and discharge controls. The ACSA Agreement only requires an independently powered communications system on

vessels where it is the policy to notify the master prior to discharging the fixed fire extinguishing system in the engine room.

- The ALASKA RANGER was not in compliance. This was an outstanding worklist item when the ALASKA RANGER left drydock in December 2007 and was included in the list of outstanding ACSA items FCA submitted to the USCG on 16 March 2008.
- GMDSS shall be installed and personnel should be trained and certified in its use. Vessels shall be in compliance with NVIC 3-99, "Global Maritime Distress and Safety System and Emergency Position Indicating Radiobeacon Equipment Requirements for Commercial Vessels".
 - In his notes in the CG-840 book from the drydock examination, the Sector Seattle CFVS Examiner indicated the GMDSS on the ALASKA RANGER was in compliance.
- AIS should be installed per 33 CFR 164.46.
 - In his notes in the CG-840 book from the drydock examination, the Sector Seattle CFVS Examiner indicated the AIS on the ALASKA RANGER was in compliance.

Vessel classification and load line requirements did not contain any comparable requirements.

Fire Safety

The ACSA Agreement contained the following fire fighting requirements:

- Conduct an annual Fire Safety Hazard Survey to identify and remedy fire safety hazards.
 - This was not included as an outstanding worklist item and was not mentioned in the CG-840 book from the drydock examination.
- Be provided with a portable, self-priming, independently powered fire/bilge pump.
 - Testimony of the crew indicated the ALASKA RANGER had a portable diesel pump and was in compliance at the time of the casualty.
- Be provided with at least four (4) fireman's outfits, as described in 46 CFR 96.35, if 26 or more people on board. Each outfit should have a Self-Contained Breathing Apparatus (SCBA) and two spare air bottles.
 - Based on the evidence collected, the MBI could not determine if the ALASKA RANGER was in compliance. This was identified as a deficiency on the ALASKA RANGER during the preliminary ACSA examination on 20 June 2006. It was also included as an outstanding worklist item when the ALASKA RANGER left drydock

in December 2007. However, it was not included in the list of outstanding ACSA items FCA submitted to the USCG on 16 March 2008.

- Have a current Fire and Safety Plan posted.
 - The ALASKA RANGER was not in compliance. It did not have a current Fire and Safety Plan. This was one of the outstanding worklist items from the drydock exam and was also in the list of outstanding ACSA items FCA submitted to the USCG on 16 March 2008.
- Fixed gas fire extinguishing system must be installed in any space containing an internal combustion engine of more than 50 horsepower, an oil-fired boiler, an incinerator, or a gasoline storage tank or other flammable materials, such as a paint locker. All fixed gas fire extinguishing systems for main machinery spaces shall be installed in accordance with 46 CFR Part 76, appropriate National Fire Protection Association standards, and certain actuation and alarm standards identified in ACSA.
 - The ALASKA RANGER was not in substantial compliance. While it had a fixed gas fire extinguishing system installed in the engineroom, the worklist issued when the vessel left the shipyard and the list of outstanding items FCA provided on 16 March 2008 indicated the activation bottles had been condemned when the system was last serviced and needed replacement.
- Heat detector alarms shall be installed in each space fitted with a fixed gas fire extinguishing system. Each accommodation space must be equipped with an independent modular smoke detector or a smoke actuated fire detecting unit installed in accordance with 46 CFR Part 76.33.
 - Documentation from the USCG examinations conducted in the shipyard indicated the ALASKA RANGER was in compliance.
- Crew members that are identified in the vessel's Watch, Quarter and Station Bill as fire team members, and who will wear the fireman's outfits, must attend USCG approved fire-fighting training.
 - Based on the evidence collected, the MBI could not determine if the ALASKA RANGER was in compliance.

Load line requirements did not contain any comparable requirements. Depending on the vessel's build date, length, tonnage and engine horsepower, some of these items would have been required by the ABS Rules. Had the ALASKA RANGER been classed by ABS, two fire pumps would have been required. Though there were no portable bilge pump requirements in the ACSA Agreement, the ABS Rules would have required two bilge pumps. The ABS Rules also contained requirements for Fire Control Plans, fireman's outfits, and SCBAs. Fixed fire fighting systems would have been required by the Rules for the machinery spaces. A fire detection and alarm system would have been required for the accommodation and service spaces.

Machinery

The ACSA Agreement contained the machinery requirements listed below.

- Machinery Maintenance: Main propulsion and electrical generation machinery and auxiliary systems (e.g. fuel oil, lube oil, and cooling systems) directly connected to the engines shall be maintained in accordance with the preventative maintenance standards established by the manufacturer or the manufacturer's authorized representative.
 - This item was not discussed in the CG-840 book. Based on the evidence collected, the MBI could not determine if the ALASKA RANGER was in compliance.
- Fuel Systems: All hoses carrying oil located in the engine room shall be fire resistant and comply with SAE J-1942 standards. Sight gauges on fuel tanks must be welded or brazed. Tubular gauge glasses, if fitted to diesel fuel tanks, must be of heat resistant materials, adequately protected from mechanical damage, and provided with devices that will automatically close in the event the gauge line ruptures.
 - Based on the evidence collected, the MBI could not determine if the ALASKA RANGER was in compliance. The USCG worklist issued when the ALASKA RANGER left the shipyard contained one requirement related to the fuel and hydraulic hoses.
- Guards and Exposed Hazards: Each exhaust pipe within 15 feet of an oil fuel source must be insulated or otherwise guarded to prevent ignition.
 - Based on the evidence collected, the MBI could not determine if the ALASKA RANGER was in compliance. The USCG worklist issued when the ALASKA RANGER left the shipyard contained one requirement related to exhaust piping insulation.
- Examination of Records and Tests: The USCG may review preventative maintenance records, conduct tests and inspections of main propulsion machinery, electrical generation machinery, and each auxiliary and its associated equipment, as necessary, to ensure safe operation. In general, this examination should not be more thorough than that required for a mid-term examination of an inspected vessel vice an inspection for certification.
 - In his notes in the CG-840 Book from the drydock examination, the Sector Seattle CFVS Examiner indicated the ALASKA RANGER was in compliance.

Had the ALASKA RANGER been classed by ABS, a partial listing of the survey requirements included the following:

- Annual examination and operational testing of the main and auxiliary steering gear, including any associated equipment and control systems.

- Annual examination and operation of electrical machinery, emergency sources of electrical power, and switchgear, including confirmation of the automatic operation emergency sources of power.
- Annual verification of storage, maintenance and replacement of batteries for essential and emergency services in the vessel's operational routine.
- Annual verification that remote controls for stopping machinery are in working order.
- Annual examination and operation of the bilge pumping system, including the pumps and high level alarms.
- Operational testing and examination of the bilge and ballast piping systems every five (5) years.
- Operational testing and examination of the steering machinery every five (5) years. The machinery may have been opened for further examination, if deemed necessary by the surveyor.
- Operational testing and examination of several other machinery systems every five (5) years, including main engines, fuel oil system, main propulsion gears, compressed air system, generators, switchboards and distribution panels, cables and electrical circuits.
- A dock trial every five (5) years to confirm satisfactory operation of main and auxiliary machinery.

USCG Performance

According to the ACSA Agreement, the success of ACSA substantially depended upon a high level of coordination and interfacing between D13 and D17 and the affected fishing industry. ACSA stated the USCG intended to provide a high level of supervision and oversight to the ACSA program “until it is fully established and functioning at a high level.” Testimony and other evidence collected by the MBI shows that USCG oversight, coordination and cooperation was lacking.

The authors of ACSA collaborated with fishing industry partners to develop requirements they believed were equivalent to class and load line standards. During its development and review, certain elements were discussed and dismissed due to concern they would be “non starters” with the industry (e.g. structural fire protection requirements). Believing that ACSA requirements addressed safety problems with the fleet and incorporated recommendations from previous marine casualty investigations, the ACSA authors were confident compliance with the ACSA requirements would increase the level of safety for H&G vessels that operated as fish processing vessels.

However, the ACSA requirements were not fully implemented or enforced. The authors and other USCG personnel charged with implementing the program were fearful that vessel operators would cease processing activities, disenroll from ACSA, and revert to simple “head and gut”

operations if the ACSA standards were too difficult or costly to achieve. If ACSA vessels dropped out of the program, they believed the USCG would have lost an opportunity to improve the safety of the fleet. Consequently, these personnel accepted less than full compliance.

The USCG did not enforce the timeline. While one vessel completed all ACSA requirements on 29 December 2006 and eight others were in full compliance before August 2007, the majority of vessels that filed applications to enroll in ACSA did not take all necessary steps to come into compliance before 1 January 2008 and did not request extensions.

Based on testimony from the Sector Seattle CFVS Examiner, and documentation he provided to the MBI, only 12 of the 55 vessels enrolled in ACSA satisfied all requirements before the 1 January 2008 deadline. No vessel was offered full entry into ACSA and an exemption letter from D13 or D17 until 26 March 2008. Vessels continued to operate even though they were not in compliance, had not been exempted from the regulations, and had not been provided an extension. No penalties, operational controls, or other enforcement actions were initiated by the USCG.

Adequate USCG resources were not provided to properly conduct the necessary vessel examinations. The Sector Seattle CFVS Examiner, D13 CFVS Coordinator, and D13 Assistant Chief, Compliance & Investigations Branch, testified the number of vessels seeking enrollment exceeded their expectations and overwhelmed the Sector Seattle CFVS Examiner, who performed nearly all examinations on all vessels enrolling into ACSA.

Though he provided a level of consistency across all the vessels, the Sector Seattle CFVS Examiner did not require compliance with all ACSA requirements. On the ALASKA RANGER an internal structural examination was not conducted in each tank, tailshafts were not inspected, gauging were not taken in the aft ballast tanks, which are normally prone to extensive corrosion and, in this case, hidden from external inspection by the outer transom. In addition, the thickness of the existing hull plating was not confirmed to be in compliance with ABS Rules, and the structural deficiencies identified by the FEA CT MI in the port aft ballast tank were not addressed or included on the worklist. Tanks were allowed to be closed before inspections and necessary repairs were completed, and the ALASKA RANGER was permitted to depart the shipyard and operate with known structural defects.

ACSA examinations were poorly documented. USCG examinations were not recorded in a timely manner (e.g. the November 2007 drydock worklist issued to the ALASKA RANGER was not entered into MISLE until the day after the vessel sank). Though required in the ACSA Agreement, worklists generated during the ACSA examinations did not provide specific completion dates for the deficiencies. Because an accurate record of the outstanding deficiencies was not maintained, the USCG was unable to determine whether the vessels were correcting deficiencies and achieving compliance with ACSA requirements. As a result, on 28 February 2008 the USCG had to send a letter to every fish processing vessel owner or operator enrolled in ACSA to determine the status of compliance for each vessel.

Though already overwhelmed with the workload, the Sector Seattle CFVS Examiner attempted to travel to Dutch Harbor to conduct “pre-inspections” on the FCA vessels and assist FCA and

TMPS with the identification of necessary repairs before the vessels went to the shipyard. In addition, he devoted approximately one month of his time to do just five FCA vessels overseas in Japan, where dedicated USCG MIs are already stationed to conduct USCG inspections. Similarly, he wanted to travel to Dutch Harbor to follow-up and clear the deficiencies he issued in the shipyard, rather than let qualified personnel from Sector Anchorage address them.

It is not customary for USCG MIs to conduct pre-inspections or travel outside the geographic boundaries of their respective inspection zones to conduct inspections or clear deficiencies. Instead, USCG MIs regularly clear deficiencies issued by other USCG MIs in other OCMI zones.

The Commandant Policy Letter and ACSA both stated the drydock and internal structural examinations should comply with the requirements in 46 CFR 61.20-5 through 61.20-23, the same standards applied to vessels inspected and certificated by the USCG. In addition, where guidance was needed, the requirements for inspected vessels were to be used as they are considered equivalent to the requirements for classification and maintenance of a Load Line Certificate. However, the drydock and internal structural examinations conducted on ACSA vessels were not as thorough as those normally conducted on inspected vessels undergoing similar examinations or load line surveys.

In the case of the ALASKA RANGER, tests and examinations required on inspected vessels were not conducted and repairs, which would have normally been completed in the shipyard, were deferred. The Sector Seattle CFVS Examiner did not apply the requirements for inspected vessels when evaluating the hull, framing, and other structural members, as specified by the ACSA Agreement and Commandant Policy Letter. Though FEACT MIs are normally responsible for all examinations of inspected vessels in Japan, the Sector Seattle CFVS Examiner felt obligated to ensure the FEACT MIs understood ACSA vessels were not inspected vessels and requirements that apply to inspected vessels did not apply to ACSA vessels. The FEACT MIs stated vessels inspected by the USCG would not be permitted to operate with structural deficiencies like those left uncorrected on board the ALASKA RANGER when it departed the shipyard in 2007.

On 17 January 2008, just two months after it left the shipyard in Japan, an MI from MSD Unalaska entered the forepeak tank of the ALASKA RANGER to clear a structural deficiency identified during the internal structural examination. Because he and his supervisors believed the USCG did not have the authority to require testing, he relied only on a visual inspection of the repair and did not require the adequacy of the new welds to be confirmed using non-destructive testing, as is normally done for hull repairs on inspected vessels.

During his examination of the repair, the MSD Unalaska MI identified other structural deficiencies that needed permanent repairs but were not identified for repair by FCA or the attending USCG MIs in Japan and were not listed as outstanding deficiencies on the worklist. Based on his experience and judgment, he considered these additional items to be major repairs and issued three additional worklist items requiring the structural deficiencies be corrected.

Although he had only recently been assigned as supervisor of the commercial fishing vessel safety program at the Sector Anchorage and was not involved in the development of the ACSA program, the Sector Anchorage Chief of Inspections (CID) conducted one ACSA drydock examination and concluded the ACSA requirements were not nearly equivalent to those required by class and load line. The Sector Anchorage CID had extensive marine inspections experience and held Drydock, Hull and Machinery Inspector qualifications.

In summary, the USCG provided an insufficient number of properly trained resources to meet the workload, the requirements were not properly applied, the quality of the inspections is suspect, inspections results were not documented in a timely fashion, and the enrollment deadlines were not enforced. As a result, the ALASKA RANGER, and possibly other vessels that were enrolled into ACSA and received exemptions, likely did not achieve a level of safety equivalent to that provided by compliance with the applicable USCG regulations and classification and load line requirements.

Page Intentionally Left Blank

Conclusions

Casualty

1. Shortly after 0430 on 23 March 2008, the ALASKA RANGER sank approximately 130 miles west of Dutch Harbor, AK. 42 crewmembers were rescued by the USCG and the ALASKA WARRIOR, another fish processing vessel operated by FCA. Five crew members were lost, including the Captain, Mate, Chief Engineer, and Fish Master, who remains missing and is presumed dead.
2. The cause of the sinking was progressive flooding in the engine room and other spaces at the stern of the vessel. The flooding most likely commenced in the rudder room and subsequently spread to adjacent spaces due to a lack of watertight integrity in the internal bulkheads and decks. The buoyancy lost due to the flooding reduced the after freeboard until the stern was entirely submerged, which likely led to additional downflooding. Water filling the engine room produced a significant free surface effect, further degrading the vessel's ability to remain upright. After flooding for at least 2 hours, the vessel assumed a starboard list of approximately 45° and sank approximately 10 minutes later.
3. Though the exact initiating event that created the source of flooding is unknown, it was likely related to the poor material condition of the vessel and may have been related to the Kort nozzle struts, which are believed to have experienced excessive stresses where they were attached to the hull.
4. The ALASKA RANGER was going astern when the crew abandoned ship, just prior to the vessel sinking. The astern movement impeded the ability of the crew to safely enter liferafts directly from the vessel. The ALASKA RANGER had unexpectedly gone astern on at least one other occasion in 1996 when the vessel lost electrical power while moored at the pier.
5. It is unknown if the Captain and Mate were aware of the remote main engine emergency shutdowns located in the pilot house.
6. It is unknown if the Captain and Mate were aware the ALASKA RANGER could begin going astern if the controllable pitch propeller system lost hydraulic pressure.
7. The crew did not use the two independent diesel generators in the engine room or the harbor generator in the harbor generator room, located above on the main deck, as alternate sources of power. Instead, they continued to rely on electrical power provided by the shaft generators the engine room, which was flooding.
8. Efforts to control the flooding and dewater the vessel were aborted only moments after the flooding was discovered. The portable dewatering pump was never used.
9. The Chief Engineer likely ordered the engine room abandoned because he either concluded the amount or rate of flooding far exceeded the capacity of the pump, or he simply panicked.

10. The muster of the crew in the pilot house was rapid and orderly. The majority of crew members quickly donned survival suits, but distribution of the suits did not address proper sizing for all individuals. The Captain was wearing a “jumbo” suit even though he was relatively small compared to other crew members. Similarly, the survival suits provided to the crew member who fell from the rescue basket of the HH-65, the Mate, and three severely hypothermic survivors that lost consciousness were filled with water and were likely too large.

11. Throughout the casualty response and abandon ship evolution, the officers and crew of the ALASKA RANGER assisted and cooperated with each other. Individuals ensured others were woken, properly accounted for, and remained calm. In addition, once they abandoned the vessel they helped each other enter liferafts.

12. The Captain wanted to remain aboard the flooding vessel as long as possible, hoping rescue assets would arrive before the vessel sank. In this case, the apparent reluctance to abandon ship when it was possible to do so in a safe, orderly manner resulted in a sudden, chaotic abandonment under extremely challenging conditions.

13. The response actions of the Japanese foreign fisheries specialists were separate and independent of the response actions of the U.S. crew members. Rather than act as a single crew working together under the direction and command of the Captain or Mate, the Japanese crew members reported directly to the Fish Master.

14. The Fish Master may not have successfully abandoned ship. Most witnesses last saw the Fish Master in the pilot house with his survival suit only halfway up.

15. There is insufficient evidence to conclude the ALASKA RANGER’s previous transits or fishing operations in ice were a causal factor.

16. Fishing and factory operations were not underway on the ALASKA RANGER at the time of the casualty and were not a causal factor. Similarly, the vessel’s loading condition was not a contributing factor in the casualty.

17. While the sudden and complete loss of a rudder would have resulted in significant flooding in the rudder room, this scenario is considered unlikely. No work was done to the rudder while in the dry dock in 2007. The Assistant Engineers regularly entered the rudder room to grease the packing for each rudder and would likely have noticed anomalies with the rudder assembly or heard odd noises as it loosened.

Rescue

18. Within five and one-half hours of the ALASKA RANGER sinking, all but one of the crew members had been recovered. Two USCG aircraft had successfully located and hoisted 20 survivors and one deceased crew member from the water and delivered them to the CGC MUNRO. The ALASKA WARRIOR had retrieved 22 survivors from two liferafts and three deceased crew members from the water.

19. The HH-65 failed to safely recover one severely hypothermic crew member. The Flight Mechanic watched the Rescue Swimmer struggle for several minutes while attempting to properly place Crew Member A into the rescue basket. The Flight Mechanic deviated from the written procedures and initiated the hoist before the Rescue Swimmer provided the “ready to be hoisted” signal. The Rescue Swimmer deviated from the written procedures by not maintaining eye contact with the basket when he departed to assist another crewmember. Crew Member A was not seated securely in the rescue basket and fell before he could be safely placed in the cabin.

20. It is unknown whether the fall from the HH-65 rescue basket caused or contributed to the death of the Crew Member A. According to the personnel who recovered and attempted to revive him, there were no physical injuries visible on his body.

21. The Flight Mechanic had to turn away from Crew Member A to reach for the knife or shroud cutter stored in the helicopter. Had these tools been within reach of the Flight Mechanic, he may have been able to drain water from the suit and recover Crew Member A.

22. The HH-60 incorrectly reported to the CGC MUNRO that they had recovered 13 survivors when only 12 survivors were actually aboard the aircraft. Though some personnel aboard the CGC MUNRO counted the survivors being lowered from the HH-60 and knew there were only 12 survivors, the CGC MUNRO passed the incorrect number to D17.

23. Believing all 47 crew members were accounted for, the USCG prematurely suspended search and rescue efforts and did not realize one person, the Fish Master, was still missing until approximately two hours later. Before the search was initially suspended, the HH-60, HH-65, and ALASKA WARRIOR found and recovered the other 46 people from the ship, including four that were deceased. Though the search quickly resumed and continued for another 33 hours, the Fish Master was never found and is presumed dead.

Vessel

24. Details and arrangements regarding the actual installation of the Kort nozzles in 1991 could not be determined. However, structural modifications recommended in installation drawings provided to FCA by the manufacturer were not completed. Compliance with the manufacturer’s installation design would have required substantial structural modifications to the hull plating, bulkheads, and internal framing in the potable water tanks, rudder room, cofferdams, aft ballast tanks, and #4 fuel oil tanks. Instead of being joined directly to internal hull structure reinforced to support the forces and associated stresses, the Kort nozzle struts were simply attached to the outer hull plating.

25. Internal framing in the port aft ballast tank was significantly corroded in way of the hull plating where the port Kort nozzle struts were attached.

26. Fractures in the Kort nozzle struts were regularly discovered and repaired. If a fracture in one of the Kort nozzle struts propagated through the hull plating, it would have caused flooding in the rudder room.

27. The transom stern of the vessel was covered by an outer transom, creating an inaccessible void. During the drydock period in 2007, neither FCA nor the USCG ensured the material condition of the plating and stiffeners of the actual transom were closely examined or gauged.

28. The engineers aboard the ALASKA RANGER at the time of the casualty were not properly licensed to serve in their assigned positions. Per 46 USC 8404, both Assistant Engineers and the Chief Engineer should have held a USCG license. The Night Engineer did not hold a USCG license or any other Merchant Mariner Credential. Neither the Chief Engineer nor Day Engineer had sufficient horsepower rating to serve aboard the ALASKA RANGER.

29. The Night Engineer was directly involved in the casualty, but was not chemically tested for evidence of dangerous drugs and alcohol, a violation of 46 CFR 16.240.

30. While serving with the previous Captain on earlier trips in 2008, the Fish Master was in control of the ALASKA RANGER, a violation of 46 USC 8103(a) and 46 USC 8304.

Management

31. FCA and TMPS failed to properly maintain the structural condition of the ALASKA RANGER. The cause of extensive and repeated fracturing of the Kort nozzle struts, and structural failures in the aft ballast tanks and potable water tanks, was not properly identified. Fractures were typically repaired when discovered, but given the reoccurrence and frequency of fractures in way of the Kort nozzles and other structural members in the aft portion of the hull, TMPS and FCA should have sought the counsel of competent structural engineers. Sufficient investigation should have been conducted to determine the cause of the failures and appropriate corrective measures should have been implemented.

32. FCA and TMPS were aware significant structural repairs were needed inside the aft ballast tanks of the ALASKA RANGER before the vessel entered the shipyard in the fall of 2007. They did not obtain an assessment from a qualified structural engineer, failed to ensure proper repairs were completed in the tanks, and permitted the vessel to continue operating despite the structural deficiencies.

33. FCA's safety management practices and policies were representative of the fishing industry as a whole. In comparison to other fishing vessel operators, FCA was considered by experienced USCG Commercial Fishing Vessel Examiners to be a responsible operator and committed to safety.

34. At the time of the casualty, FCA's chemical testing program was not in compliance with USCG regulations.

Compliance with Applicable Standards

35. The material condition of the ALASKA RANGER at the time of the casualty would likely not have satisfied load line or survey and classification requirements.

36. A Sector Seattle CFVS Examiner attended ALASKA RANGER less than four months before the casualty while the vessel was in the shipyard. He failed to properly inspect the vessel and did not apply or enforce the ACSA requirements and guidance in Commandant (G-PCV) Policy Letter 03-06, "Exemption Letters for Fish Processing Vessels." An internal structural examination was not conducted in each tank, tailshafts were not inspected, gaugings were not taken in the aft ballast tanks, which are normally prone to extensive corrosion and, in this case, hidden from external inspection by the outer transom. In addition, the thickness of the existing hull plating was not confirmed to be in compliance with the ABS Rules, and the structural deficiencies identified by the FEACTION MI in the port aft ballast tank were not addressed or included on the worklist. Tanks were allowed to be closed before inspections and necessary repairs were completed, and the ALASKA RANGER was permitted to depart the shipyard and operate with known structural defects. Despite his 32-day presence at the shipyard in Japan and assistance from other qualified USCG MIs, compliance with the minimum safety standards contained in ACSA was not required or achieved.

37. On 28 February 2008, D13 provided the ALASKA RANGER a 30-day exemption from the survey and classification requirements in 46 CFR 28.720 and the load line requirements in 46 USC 5102 and 46 CFR Subchapter E. This 30-day exemption was valid at the time of the casualty.

38. ACSA was not effectively implemented or enforced on the ALASKA RANGER, which had several outstanding deficiencies and was not in compliance with all ACSA requirements at the time of the casualty. Like the majority of other fish processing vessels that entered into ACSA, the ALASKA RANGER failed to meet the compliance deadlines established by D13, D17, and the Commandant.

39. The exemption requirements in 46 CFR 28.60 and Commandant (G-PCV) Policy Letter 03-06, "Exemption Letters for Existing Fish Processing Vessels," were not satisfied for the ALASKA RANGER when it received its 30-day exemption from the survey and classification requirements and the load line requirements. FCA was not required to articulate why "good cause" existed or explain why classification was not being pursued. In addition, FCA did not demonstrate how they provided a level of safety equivalent to that provided by class and load line.

40. After the ALASKA RANGER enrolled in ACSA, the USCG did not enforce 46 CFR 28.710. As a result, the ALASKA RANGER did not have a valid certificate of compliance at the time of the casualty.

41. Though the survival suit strobe lights required by ACSA may have contributed to the survival of 42 crew members, compliance with the load line, classification and certificate of compliance requirements would have provided a greater margin of safety for the ALASKA RANGER. Had the applicable standards been enforced and FCA been required to maintain the watertight integrity of the ALASKA RANGER, the sinking may have been avoided, eliminating the need for the crew to abandon ship.

42. Because the ALASKA RANGER was a fish processing vessel, the CFVS Decal issued by the CFVS Examiner in Dutch Harbor, AK, on 17 January 2007 was invalid.

43. The survey and classification requirements in 46 CFR 28.720 only apply to fish processing vessels that are built after or undergo a major conversion completed after 27 July 1990. The authority to make major conversion determinations has been delegated from the Commandant to the MSC. Without a major conversion determination from the MSC, the applicability of 46 CFR 28.720 to the ALASKA RANGER and other fish processing vessels cannot be properly determined. This is overlooked by ACSA and major conversion determinations were not obtained from the MSC for vessels enrolled in ACSA.

ACSA Program

44. The USCG implementation of the ACSA program was severely inadequate. Sector Seattle failed to provide a sufficient amount of qualified personnel to enforce the requirements and bring all vessels into compliance by the published deadline of 1 January 2008. Sector Seattle, Sector Anchorage, D13, and D17 failed to conduct oversight and effectively coordinate with each other during the program's implementation to ensure standards were properly enforced, deadlines were met, and documentation and casework were properly completed. Interpretations of ACSA program requirements and policy evolved as it was implemented, creating considerable confusion.

45. Enrollment in the ACSA program did not provide a margin of safety equivalent to that achieved by compliance with the classification and load line design and survey requirements. By providing exemptions, ACSA likely prolonged the life of older fish processing vessels that are unable to meet classification and load line requirements. In lieu of satisfying the hull material condition and machinery requirements required by class and load line standards, vessels enrolled in ACSA were subjected to additional emergency preparedness, communications, and lifesaving requirements. Consequently, ACSA sacrificed prevention standards for improved response capabilities.

46. With only a few exceptions, the Sector Seattle CFVS Examiner that led the USCG drydock and internal structural examinations on the ALASKA RANGER led the examinations on all other fish processing vessels that enrolled in ACSA. Based on his performance during the ALASKA RANGER examinations, the material condition and level of compliance for other vessels currently enrolled in ACSA is suspect.

47. USCG personnel conducting ACSA examinations and managing its implementation viewed it as a voluntary program and felt they did not have the authority to compel compliance. They feared that if vessel owners became too inconvenienced by the program's impact on fishing schedules or deficiency corrections became too costly, vessel owners might elect to drop out of ACSA and stop processing rather than comply with class and load line requirements. Should an owner disenroll his vessel from ACSA, USCG personnel believed they would lose all ability to exert influence and improve the vessel's safety. As a result, they accepted less than complete compliance with ACSA requirements under the guise of continuous improvement.

48. ACSA incorrectly presumed authorized class societies would not permit fish processing vessels more than 20 years old to obtain classification or a load line. Though ABS revised its policy after the casualty and will no longer class fishing vessels more than 10 years old, DNV has no such restrictions and will class any fish processing vessel that satisfies the applicable requirements. ABS will issue a load line on behalf of the USCG to any eligible vessel that satisfies the requirements, regardless of its age. DNV is authorized to act on the USCG's behalf and will issue a load line to fish processing vessels that are also classed by DNV. Lloyd's Register, Germanischer Lloyd, and Bureau Veritas are also authorized to issue Load Line Certificates on the USCG's behalf.

49. Vessel stability is one of the primary cornerstones of ACSA, and the program relies substantially on the work performed by the naval architect. However, unlike the stability requirements for load line assignment, which normally require review and approval by the USCG or an authorized classification society, ACSA does not require an independent review and assessment of work completed by the naval architect. ACSA's vessel stability requirements require inclining experiments, stability instructions, an assessment to determine the maximum allowable draft, and development of a stability addendum. However, ACSA does not require review by a qualified third party or certification by a licensed professional engineer. Without an independent review, or professional engineer's certification, of these key requirements, particularly in the absence of clear standards, compliance cannot be assured.

50. ACSA significantly simplified the process of identifying fish processing vessels by incorporating NFMS product codes into the definition. This removed ambiguity for the USCG and industry and allowed all parties to determine applicability of the ACSA standards by simply examining the NMFS product codes reported for each vessel. However, like the existing regulatory definitions, ACSA definitions were unrelated to the vessel's risk (route, number of crew members, etc.).

General

51. The safety problems associated with commercial fishing vessels are beyond the scope of effective action through voluntary measures. Enforcement of existing Load Line and Class requirements is hampered by current regulatory commercial fishing vessel definitions that are not based on risk and are difficult to apply and enforce. Mandatory, regular examinations are necessary to ensure minimum standards are satisfied and maintained.

52. The inability of vessel owners to replace existing vessels with new ones that meet the most stringent safety requirements unnecessarily impedes safety improvements and puts vessels and crews at greater risk. The drafters of the Commercial Fishing Vessel Industry Safety Act of 1988 assumed older vessels would be replaced with new vessels that comply with the most stringent safety requirements, yet fishery conservation regulations prohibit replacement of existing vessels in the non-AFA catcher processor fleet.

53. The 1985 revision to the statutory definition that allowed fishing vessels to "freeze" fish products enabled fishing vessels to operate like fish processing vessels (e.g. more complex factory spaces operated by larger crews further from shore and for longer periods of time) without complying with additional safety requirements.

54. Annual inspection requirements may be unsuitable to guarantee survival suit lights will work when needed. Although the suits had been inspected only two months prior to the casualty, several survival suit strobe lights did not function properly or fell off of the suits and were lost when crew members abandoned ship.

55. 33 CFR 95 does not prohibit crew members from consuming alcohol while operating an uninspected commercial vessel. This is unacceptable.

56. Current regulations require all seagoing commercial vessels over 200 GT to provide licensed engineers when an engineering watch is provided. USCG policy in the USCG Marine Safety Manual, Volume III, Marine Industry Personnel, states seagoing uninspected towing vessels over 200 GT must employ licensed engineers when a watch is provided, but does not specifically mention commercial fishing vessels. This omission leads the reader to believe the requirement does not extend to seagoing commercial fishing vessels.

57. Though not an apparent causal factor in this casualty, and also common on other fish processing vessels, crew endurance risk factors were prevalent in the work environment aboard the ALASKA RANGER and caused extensive crew member fatigue. The work schedule for the factory workers required them to compete against their daily physiological (circadian) rhythms by having to work during the night and experience inconsistent sleep/wake patterns. 12-hour work periods combined with six-hour rest periods between shifts induced physical and mental fatigue.

58. The training, instructions and drill program aboard the ALASKA RANGER did not include all ten elements required by 46 CFR 28.270. Like the majority of fishing vessel operators, FCA does not have a written training program to ensure all elements are included, or written emergency procedures for officers and crew to follow in an emergency. As a result, training and procedures varied, officers were unaware of the existence of key emergency safety equipment, and the crew was not prepared for all aspects of the emergency situation it faced.

59. The engine room high bilge water actuators were placed too high in the bilges allowing unnecessarily large amounts of bilge water to accumulate before sounding an alarm. Generally, alarm actuators should not be installed so low as to create nuisance alarms or so high as to permit an excessive amount of water to accumulate and alarm too late.

60. The Meritorious Public Service Award presented to the officers and crew of the ALASKA WARRIOR in recognition of their heroic efforts to rescue the crew members from the ALASKA RANGER was well-deserved.

61. The awards presented to the CGC MUNRO and crews of the HH-60 and HH-65 in recognition of their heroic efforts to rescue the crew members from the ALASKA RANGER were well-deserved.

Recommendations

1. The USCG should broadly interpret and thoroughly apply all existing commercial fishing vessel regulations to best accomplish their purpose: safety. Waivers and exemptions should be minimized.
2. The Commandant should review and revise the comprehensive commercial fishing vessel inspection plan proposed in 1992, and, again, request the additional legislative authority and resources necessary to implement an inspection program. This inspection program should include mandatory, regular inspections.
3. The Commandant should ensure regulatory safety requirements for commercial fishing industry vessels are revised so they are commensurate with the route, number of people on board, complexity of operations, and other applicable risk factors.
4. The Commandant should ensure the regulatory definition for “fish processing vessel” is revised to remove existing ambiguity and facilitate enforcement.
5. The Commandant, NMFS, and the North Pacific Fishery Management Council should harmonize safety and conservation regulations. Safety and resource management decisions and requirements should complement each other. Fishing industry vessel owners should be encouraged to replace existing, older vessels with newer ones that meet the most stringent safety requirements.
6. The ACSA program should be disestablished.
7. OCMi Seattle, OCMi Western Alaska, D13 and D17 should not issue or renew any exemptions, waivers, or equivalencies under ACSA.
8. Assisted by experienced specialists from the Commandant’s Office of Quality Assurance & Traveling Inspections (CG-546), OCMi Seattle, OCMi Western Alaska, D13 and D17 should examine and confirm the structural and material condition of all fish processing vessels currently operating with exemptions issued under ACSA.
9. Based on the results of the examinations discussed above, those vessels not likely to meet class and load line requirements should be immediately disenrolled from ACSA by the OCMi Seattle, OCMi Western Alaska, D13 or D17 and prohibited from operating as a fish processing vessel until they demonstrate compliance. Others should be given a sufficient amount of time necessary to obtain a load line and become classed, as necessary.
10. Unless the operator can demonstrate it was a fish processing vessel before 27 July 1990, the OCMi Seattle, OCMi Western Alaska, D13 and D17 should immediately require each existing fish processing vessel to comply with 46 CFR 28.720 and be classed by a qualified organization. Vessels unable to comply should be prohibited from operating as a fish processing vessel.

11. Unless it is less than 5000 GT and the operator can demonstrate it was constructed as a fish processing vessel before August 16, 1974 or converted to a fish processor before January 1, 1983, the OCMI Seattle, OCMI Western Alaska, D13 and D17 should immediately require each existing fish processing vessel to comply with 46 CFR Subchapter E and obtain a load line. Vessels unable to comply should be prohibited from operating as fish processing vessels.

12. If the ACSA program is continued, Commandant, D13, and D17 must reevaluate ACSA standards and procedures and ensure they provide a level of safety equivalent to that provided by the applicable regulations. In addition, there must be adequate oversight to ensure the standards are properly enforced and compliance is achieved. For example, the vessel stability requirements in ACSA must provide clear standards to participating naval architects. In addition, the stability analyses produced by naval architects for vessel operators should be reviewed by the USCG MSC or a qualified third party.

13. The Commandant should clearly state that a change of service from a "fishing vessel" to a "fish processing vessel" is a major conversion per 46 USC 2101(14a). Any commercial fishing industry vessel that changes service and begins operating as a fish processing vessel after 27 July 1990 should be required to meet the survey and classification requirements in 46 CFR 28.720.

14. The Commandant should clarify and enforce the regulatory requirements regarding the use of licensed engineering personnel on commercial fishing vessels and fish processing vessels that elect to provide an engineering watch.

15. The Commandant should initiate regulatory changes to prohibit the use of alcohol aboard commercial fishing industry vessels. This is consistent with the 1987 National Transportation Safety Board study, "Uninspected Commercial Fishing Vessel Safety," which recommended an absolute prohibition against the use of alcohol and/or drugs while engaged in commercial fishing operations.

16. The Commandant should develop and publish standards for the proper placement of bilge high level alarm actuators to provide the earliest warnings of abnormal bilge accumulation for all vessels, and establish inspection and verification procedures for inspected vessels to ensure they are properly installed. Current inspection procedures ensure bilge high level alarms are operable, but, without a standard for placement of the actuator, there is no inspection requirement or practice to verify the height of the alarm actuator above the bilge.

17. The Commandant should include standards for the placement of bilge high level alarm actuators and inspection and verification procedures for high bilge alarm actuators in the proposed amendments to the commercial fishing industry vessel regulations (Docket No. USCG-2003-16158).

18. As part of the proposed amendments to its commercial fishing industry vessel regulations (Docket No. USCG-2003-16158), the Commandant should consider increasing the frequency of inspections for personal lifesaving equipment, such as survival suit lights, to ensure this valuable equipment is ready when needed.

19. As part of the proposed amendments to its commercial fishing industry vessel regulations (Docket No. USCG–2003–16158), the Commandant should consider requiring vessel owners to ensure each person onboard has a survival suit that reasonably fits body frame.
20. As part of the proposed amendments to its commercial fishing industry vessel regulations (Docket No. USCG–2003–16158), the Commandant should require masters to conduct abandon ship drills that incorporate distribution of survival suits to all persons onboard to ensure that each person receives a survival suit that reasonably fits the individual's body frame.
21. The Commandant should examine the training and proficiency requirements for Rescue Swimmers and ensure they adequately address recovery of a non-responsive or combative survivor. Regular training with life-like mannequins should be considered.
22. The Commandant should review the storage location of the shroud cutter in its HH-65 helicopters and consider moving them within arm's reach of a flight mechanic working at the doorway.
23. The Commandant should review the standard operating procedures for Mass Rescue Operations to ensure communications are efficient and effective and the accountability of all personnel, missing and recovered, is ensured.
24. USCG CVFS Examiners should educate the masters, officers and crew on the importance of correctly fitting survival suits and emphasize that individuals have ready access to a survival suit that fits reasonably.
25. FCA should consult with a competent naval architect or structural engineer and ensure existing Kort nozzles on other FCA vessels are properly installed and maintained.
26. FCA should consult with a competent naval architect or structural engineer and ensure that other vessels with outer transoms are properly gauged and internally examined to ensure the material condition of each is properly maintained.
27. FCA and other vessel owners should have written safety training instructions to ensure training and drills include all elements of the regulations and are completed as required. Written procedures minimize human error and human omission that may occur when procedures are informal and shore side personnel assume vessel personnel know and understand all aspects of the owner's policy and applicable safety regulations.
28. FCA and other vessel owners should have written emergency procedures to ensure personnel onboard understand proper procedures to follow in an emergency. Written emergency procedures document the owner's procedures and ensure that activities on board affecting safety are planned, organized, and executed in accordance with the owner's requirements and applicable safety regulations.
29. Owners and operators of vessels with controllable pitch propellers should understand how their installed system will respond to a loss of power and other likely modes of failure, develop and implement sufficient emergency procedures, and ensure officers and crews are trained to take appropriate measures.

30. USCG Safety Alert 03-08 should be widely distributed to vessel owners and operators. CFVS Examiners should provide a copy of the Safety Alert to each vessel they examine that uses controllable pitch propellers.
31. Owners and operators of fishing vessels should pay particular attention to fishing industry vessels that have outer transoms, and ensure the entire vessel is properly inspected and maintained, not just readily accessible spaces.
32. NMFS should be commended for ensuring fisheries observers are provided with personal EPIRBs and properly sized survival suits.
33. To further enhance the safety of fisheries observers, NMFS should require observers to confirm the vessel's officers are properly licensed each time they conduct a pre-trip safety check under 50 CFR Part 600.
34. The OCMI Western Alaska should initiate an investigation into possible violation of the serious marine incident chemical testing requirements in 46 CFR 16.240.
35. The OCMI Western Alaska should initiate an investigation into possible violation of the vessel manning requirement in 46 USC 8304 and 46 CFR 15.825 regarding the improperly and unlicensed engineers.
36. The OCMI Western Alaska should initiate an investigation into possible violation of the vessel manning requirement in 46 USC 8103(a) and 46 USC 8304 regarding the vessel being improperly under the control of an unlicensed non-U.S. citizen.
37. Recommend this investigation be closed.

[Redacted]

M. P. RAND, Captain, USCG

[Redacted]

J. P. NADEAU, Commander, USCG

[Redacted]

~~D. HAWKINS~~, Commander, USCG

[Redacted]

14 SEPTEMBER 2009

[Redacted]

LTJG, USCG

Appendix A: Crew List/Position/Training

The following are the Crewmembers, including their positions, license and training, who were onboard the ALASKA RANGER on March 23, 2008.

Name: Eric Peter Jacobsen*
Position: Master
CG License: Yes
Training: Drill Conductor, Drug Testing Collector

CG License: Master of Steam or Motor vessels of not more than 1600 Gross Registered Tons (Domestic Tonnage), 3000 Gross Tons (ITC Tonnage) Upon Near Coastal Waters; Radar Observer (Unlimited) Radar Expires 25 April 2010; Master of Uninspected Fishing Industry Vessels of not more than 2000 Gross Registered Tons (Domestic Tonnage) Upon Near Coastal Waters; Also, Mate of Steam or Motor Vessels of not more than 1600 Gross Registered Tons (Domestic Tonnage), 3000 Gross Tons (ITC Tonnage) upon Oceans.

Name: David Silveira*
Position: Mate
CG License: Yes
Training: Drill Conductor, Basic Firefighting, Drug Testing Collector

License: Master of Steam or Motor Vessels of not more than 1600 Gross Registered Tons (Domestic Tonnage), 3000 Gross Tons (ITC Tonnage) upon Oceans; Also, Master of Uninspected Fishing Industry Vessels of Any Gross Tons Upon Oceans, Radar Observer (Unlimited).

Name: Daniel Cook*
Position: Chief Engineer
CG License: Yes
Training: None known

License: Chief Engineer of Uninspected Fishing Industry Vessels of Not More than 6000 Horsepower (4500 KW). For Vessels Under 200 GRT (Domestic Tonnage), 500 GT (ITC Tonnage) on Domestic Voyages Only, The Holder of This License Meets STCW 1995 Regulations Without Further Endorsement.

Name: [REDACTED]
Position: Assistant Engineer
CG License: Yes
Training: None known

License: Assistant Engineer of Uninspected Fishing Industry Vessels of Not More Than 4000 Horsepower.

Name: [REDACTED]
Position: Assistant Engineer
CG License: None
Training: Basic Firefighting, Drill Conductor, 5-Day Basic Safety Training

Name: Satoshi Konno*
Position: Japanese Fish Master
CG License: None
Training: None known

Name: [REDACTED]
Position: Japanese Technician
CG License: No
Training: None known

Name: [REDACTED]
Position: Japanese Technician
CG License: No
Training: None known

Name: [REDACTED]
Position: Japanese Chief Engineer
CG License: None
Training: None known

Name: [REDACTED]
Position: Japanese Technician
CG License: None
Training: None known

Name: [REDACTED]
Position: Factory Worker
CG License: No
Training: None known

Name: [REDACTED]
Position: Factory Worker
CG License: No
Training: None known

Name: [REDACTED]
Position: Factory Worker
CG License: No
Training: None known

Name: [REDACTED]
Position: Factory Worker
CG License: No
Training: None known

Name: Byron Carrillo*
Position: Factory Worker
CG License: No
Training: None known

Name: [REDACTED]
Position: Factory Worker
CG License: No
Training: None known

Name: [REDACTED]**
Position: Bosun
CG License: None
Training: Drill Conductor, 5-Day Basic Safety Training

Name: [REDACTED]
Position: Factory Worker
CG License: No
Training: None known

Name: [REDACTED]
Position: Factory Worker
CG License: No
Training: None known

Name: [REDACTED]
Position: Steward
CG License: No
Training: 2-Day Basic Firefighting

Name: [REDACTED]
Position: Factory Worker
CG License: No
Training: None known

Name: [REDACTED]**
Position: Factory Worker
CG License: No
Training: Drill Conductor, 2-Day Basic Firefighting

Name: [REDACTED]
Position: Factory Worker
CG License: No
Training: None known

Name: [REDACTED]
Position: Assistant Cook
CG License: None
Training: None known

Name: [REDACTED]
Position: Cook
CG License: None
Training: Basic Firefighting

Name: [REDACTED]**
Position: Factory Manager
CG License: No
Training: 5-Day Basic Safety Training, HACCP

Name: [REDACTED]
Position: Crewmember
CG License: No
Training: None known

Name: [REDACTED]**
Position: Deckhand
CG License: No
Training: None known

Name: [REDACTED]
Position: Factory Worker
CG License: No
Training: 2-Day Basic Firefighting

Name: [REDACTED]
Position: Factory Worker
CG License: No
Training: None known

Name: [REDACTED]
Position: Factory Worker
CG License: No
Training: None Known

Name: [REDACTED]
Position: Factory Worker
CG License: No
Training: None known

Name: [REDACTED]**
Position: Factory Worker
CG License: No
Training: Drill Conductor

Name: [REDACTED]
Position: Factory Worker
CG License: No
Training: None known

Name: [REDACTED]**
Position: Factory Worker
CG License: No
Training: None known

Name: [REDACTED]
Position: Factory Worker
CG License: No
Training: Personal Safety

Name: [REDACTED]
Position: Factory Worker
CG License: No
Training: None known

Name: [REDACTED]
Position: Factory Worker
CG License: No
Training: 2-Day Basic Firefighting

Name: [REDACTED]
Position: Factory Worker
CG License: No
Training: None known

Name: [REDACTED]
Position: Factory Worker
CG License: No
Training: None known

Name: [REDACTED]
Position: Factory Worker
CG License: No
Training: None known

Name: [REDACTED]**
Position: Factory Leader
CG License: No
Training: Drill Conductor, 5-Day Basic Safety Training, Anti-Harassment

Name: [REDACTED]
Position: Factory Worker
CG License: No
Training: None known

Name: [REDACTED]
Position: Factory Worker
CG License: No
Training: None known

Name: [REDACTED]
Position: Factory Worker
CG License: No
Training: None known

Name: [REDACTED]
Position: NMFS Observer
CG License: No
Training: NMFS Observer Safety Training

Name: [REDACTED]
Position: NMFS Observer
CG License: No
Training: None known

Persons with an asterisk (*) are deceased or are missing and presumed dead.

Persons with two asterisks (**) are members of the emergency squad.

Appendix B: Weather Information

The National Weather Service (NWS) issued the following weather forecasts and charts for the period leading up to the sinking of the ALASKA RANGER:

NWS Forecast issued 0400 Saturday, 22 March 2008

EASTERN ALEUTIANS CAPE SARICHEF TO NIKOLSKI

GALE WARNING THROUGH SUNDAY...

HEAVY FREEZING SPRAY WARNING THROUGH SUNDAY...

TODAY...NW WIND 40 KT. SEAS 13 FT. HEAVY FREEZING SPRAY.

TONIGHT AND SUN...NW WIND 40 KT. SEAS 15 FT. HEAVY FREEZING SPRAY.

SUN NIGHT THROUGH TUE...NW WIND 35 KT. SEAS 12 FT.

WED...NW WIND 25 KT. SEAS 7 FT.

NWS Forecast Chart for 1000 22 March 2008

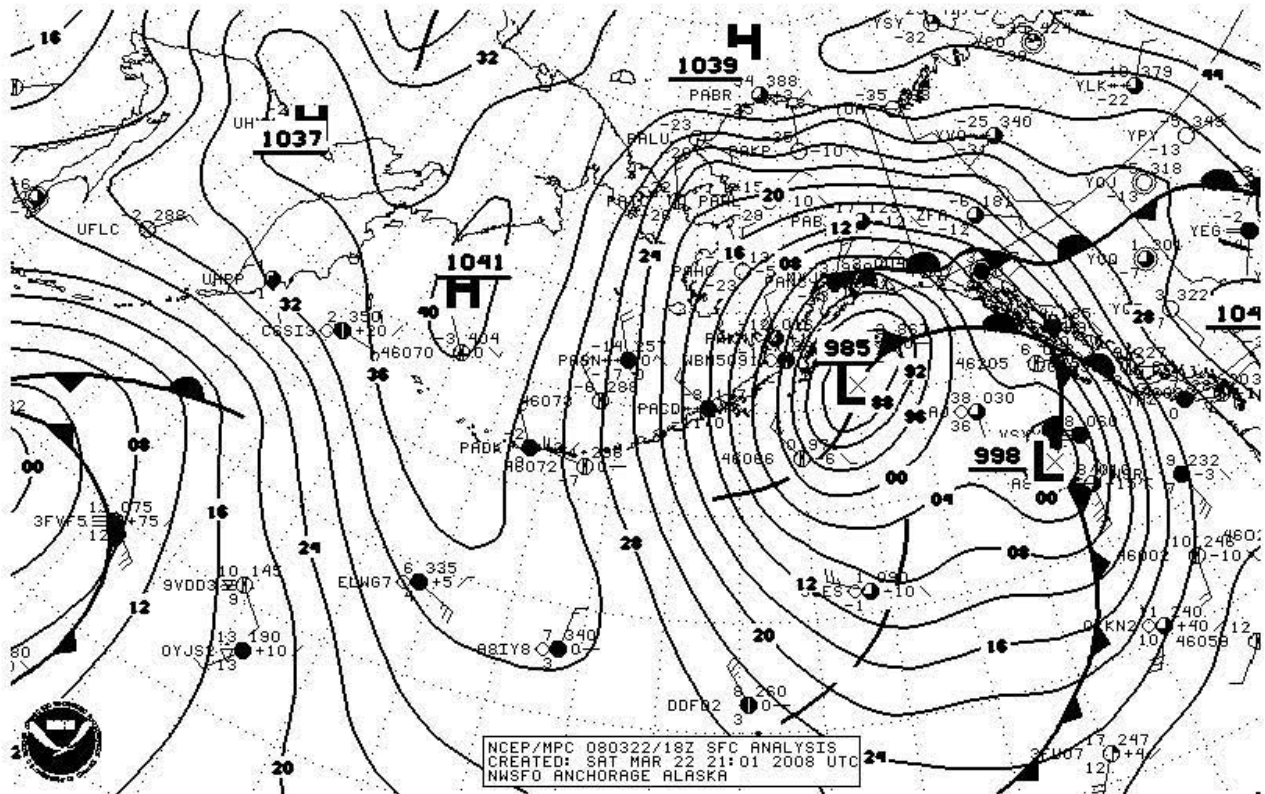

NWS Forecast issued 1600 Saturday, 22 March 2008

EASTERN ALEUTIANS CAPE SARICHEF TO NIKOLSKI

GALE WARNING THROUGH SUNDAY NIGHT...

HEAVY FREEZING SPRAY WARNING THROUGH SUNDAY NIGHT...

TONIGHT...NW WIND 40 KT. GUSTS TO 55 KT OUT OF BAYS AND PASSES. SEAS 13 FT. SNOW SHOWERS. HEAVY FREEZING SPRAY.

SUN...NW WIND 40 KT. GUSTS TO 50 KT OUT OF BAYS AND PASSES. SEAS 13 FT. SNOW SHOWERS. HEAVY FREEZING SPRAY.

SUN NIGHT...NW WIND 35 KT. SEAS 12 FT. SNOW SHOWERS. HEAVY FREEZING SPRAY.

MON THROUGH TUE...NW WIND 35 KT. SEAS 10 FT.

WED...W WIND 25 KT. SEAS 7 FT.

THU...SE WIND 20 KT. SEAS 4 FT.

NWS Forecast Chart for 1600 22 March 2008:

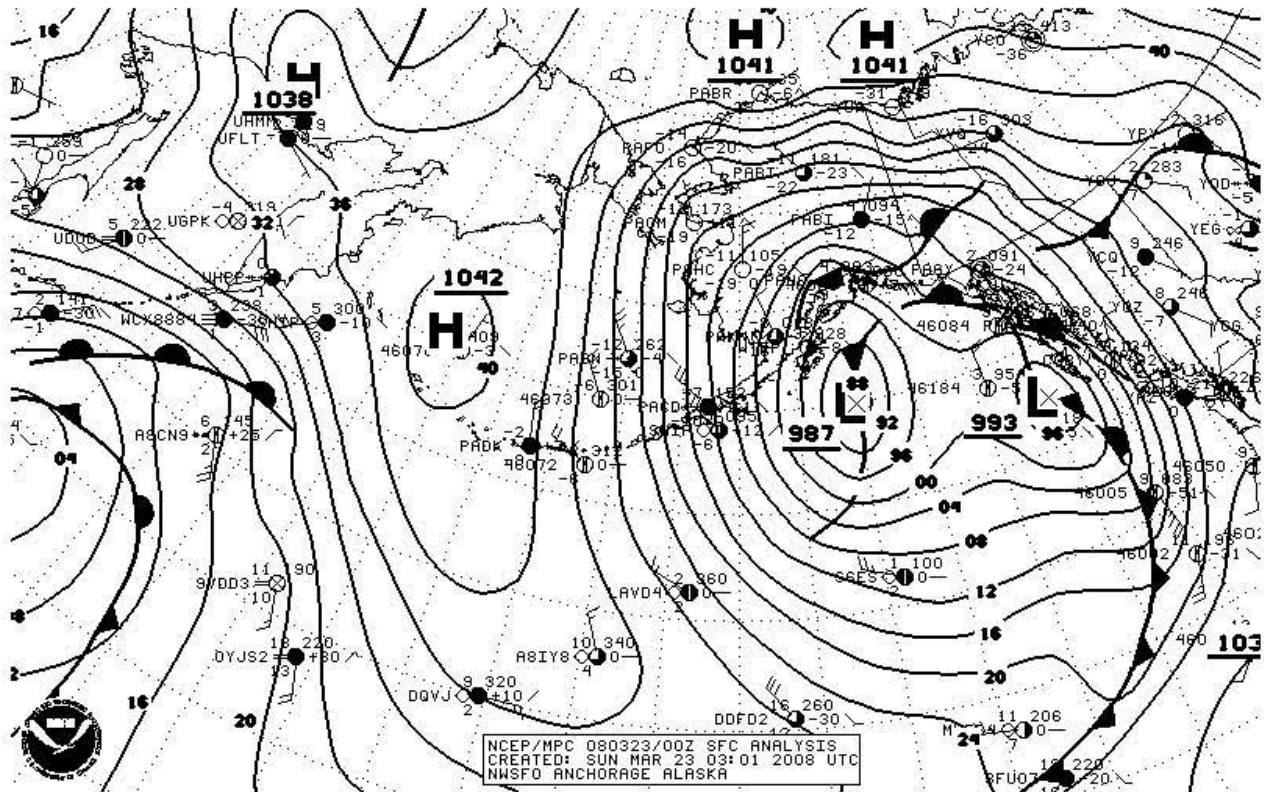

NWS Forecast Chart for 2400 Saturday, 22 March 2008

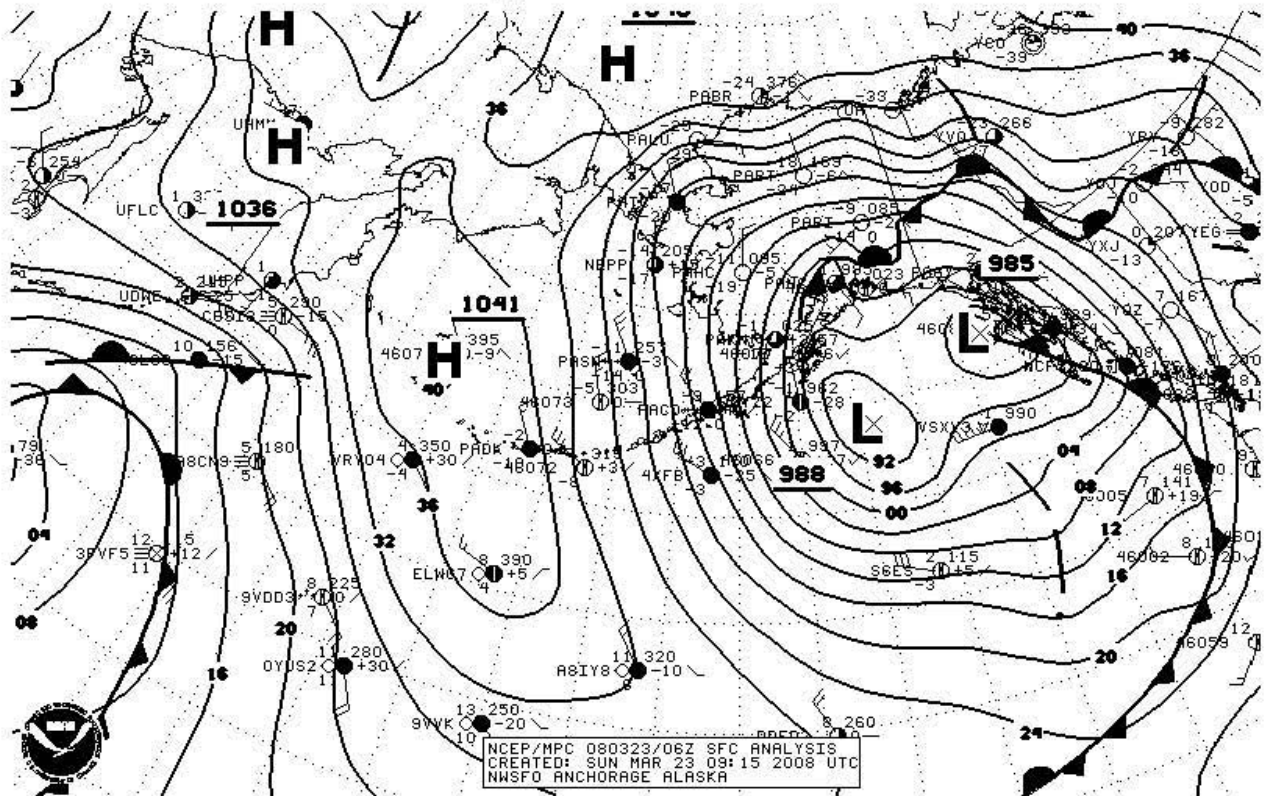

NWS Forecast issued 0400 Sunday, 23 March 2008

EASTERN ALEUTIANS CAPE SARICHEF TO NIKOLSKI

GALE WARNING THROUGH MONDAY...

HEAVY FREEZING SPRAY WARNING THROUGH MONDAY...

TODAY...NW WIND 40 KT. SEAS 13 FT. SNOW SHOWERS. HEAVY FREEZING SPRAY.

TONIGHT AND MON...NW WIND 35 KT. SEAS 11 FT. SNOW SHOWERS. HEAVY FREEZING SPRAY.

MON NIGHT AND TUE...NW WIND 35 KT. SEAS 10 FT.

WED...W WIND 25 KT. SEAS 7 FT.

THU...SE WIND 20 KT. SEAS 5 FT.

Other weather reports for the scene of the casualty include:

At 0253 on 23 March 2009, the ALASKA RANGER reported to the CGC MUNRO that they were experiencing winds of 35 knots and seas of 6-8 feet.

At 0424 on 23 March, the National Data Buoy Center was reporting the weather in the vicinity to be:

Winds:	27 KTS
Wind Direction:	310 True
Gusts:	31 KTS
Air Temperature:	25 F
Pressure:	30
Water Temperature:	35 F
Wave Height:	8 FT

At 0836 on 23 March, USCG C-130 1705 reported the weather on scene was the following:

Winds:	25-30 KTS
Wind Direction:	320 True

Rain Showers and Snow

At 0900 on 23 March 2008, the CGC MUNRO reported the weather in the area of the casualty to be:

Winds:	28KTS
Winds Direction:	310 True
Air Temperature:	17 F
Visibility:	4 NM
Pressure:	30
Water Temperature:	36 F
Wave Height:	8 FT
Wave Direction:	340 True
Swell Height:	8 FT
Swell Direction:	300 True

Gale Warning in effect at the time.

At 1215 March 23, 2008 another USCG C-130 1709 on scene reported the following:

Winds:	25 KTS
Wind Direction:	290 True
Seas:	10 FT
Visibility:	10 NM

Occasional Showers

At 2001 on March 23, 2008, approximately 14 hours after the casualty, CGC MUNRO reported the weather to be:

Winds:	26 KTS
Direction:	318 True
Air Temperature:	16 F
Wind Chill Temperature:	-24F
Water Temperature:	32 F
Barometer Pressure:	30.18

Appendix C: Glossary

AMS: A mandatory classification for all self propelled vessels indicating the vessel complied with all machinery requirements except for those associated with automation and monitoring for centralized control or unattended operation.

Amidships: The region in the vicinity of the mid-length of a ship as distinguished from the ends. Technically, it is exactly halfway between the forward and after perpendiculars.

Baseline: A fore-and-aft reference line. Vertical dimensions are measured from a horizontal plane through the baseline.

Block Coefficient: The ratio of the underwater volume of a ship to the volume of a rectangular block, the dimensions of which are the ship's length, breadth, and draft.

Bulkhead: A term applied to the partition walls that divide the interior of a ship into compartments.

Chalk Test: A chalk test is a method for testing the contact of a watertight door gasket with the knife edge of the door frame to assure that the gasket is making complete contact with the knife edge, which indicates a good seal thus preventing water intrusion. The test requires rubbing chalk on the knife edge then closing and dogging the door. The gasket of the door is then checked to assure a continuous line of chalk on the gasket. If the chalk does not form a continuous line around the gasket then the gasket is not making contact with the knife edge and could allow water intrusion.

Cod End: The bottom end of a trawl net where fish are retained. It is designed so that it may be opened up to release the fish, or a portion of the fish, into the fish bin.

Damaged Stability: The stability characteristics of a vessel whose hull is no longer intact allowing free communication between the interior of the hull and the water outside the hull.

Datum Marker Buoy: A search and rescue tool that is an air deployable location sensor configured with a transmitter that periodically transmits its location. It has the capability of emulating the drift characteristics of a person in the water.

Decal: A Commercial Fishing Vessel Safety Decal is issued when a vessel has been examined and found to be in compliance with all applicable safety regulations. The decal is valid for two years provided the vessel's safety equipment remains serviceable and the vessel does not exceed certain operating conditions.

Displacement: The weight of a vessel, which is equal to the weight of the water displaced by the volume of the hull below the waterline.

Downflooding Point: An opening in the hull or superstructure of a vessel through which water would enter the interior of the hull should the opening become submerged.

Exposed Waters: Waters more than 20 nautical miles from the mouth of a harbor of safe refuge (see 46 CFR 170.050(c)).

Frame: A term used to designate one of the transverse members that make up the rib-like part of the skeleton of the ship. The frames act as stiffeners, holding the outside plating in shape and maintaining the transverse form of the vessel.

Freeboard: The distance from the waterline to the upper surface of the deck edge.

Free Surface Effect: The resulting virtual rise of a ship's vertical center of gravity due to the carriage of liquid that is permitted to move freely in a tank or compartment of a vessel. When a tank or compartment is greater than 95% full, the free surface effect is essentially nonexistent.

Intact Stability: The stability characteristics of a vessel whose hull is intact.

Lightship: The weight of a ship complete including hull, machinery, outfit, equipment, and liquids in machinery.

Longitudinal Center of Gravity: The fore-and-aft location of the center of gravity.

Progressive Flooding: The uncontrolled, continued intrusion of water into a hull where by the water passes from one compartment into another.

Righting Arm: The distance between the buoyant force causing a ship to remain upright and the center of gravity.

Sea Painter: Line used to attach a liferaft to a vessel that keeps it from floating away, and when pulled, triggers the inflation mechanism.

Stability: The tendency of a vessel to remain upright, or the ability to return to the normal upright position when heeled by the action of waves, wind, etc.

Stability Addendum: Information required on ACSA vessels to specify watertight bulkheads and closures, through hull valves and fittings, and the maximum operating draft. It also contains factory sump pump calculations.

Transom Stern: Squared-ended stern, where the bottom edge of the transom is approximately on the waterline.

Appendix D: MSC Analysis

See next page.



16710/P014035
Serial: H1-0803304
22 Dec 2008

MEMORANDUM

From: [REDACTED]
S. P. McGee, CDR
CG MSC-1

Reply to LT [REDACTED]
Attn of: (202) 475-3387

To: M. P. Rand, CAPT
Chairman, Marine Board of Investigation

Subj: POST SINKING STABILITY ANALYSIS FOR THE ALASKA RANGER, O.N.
550138

Ref: (a) Your memo dated 18 Aug 2008

1. As requested in ref (a), we reviewed Elliott Bay Design Group's stability calculations used to develop the ALASKA RANGER's Trim and Stability (T&S) Booklet. We found that all the applicable intact stability criteria were met for each loading condition listed. As detailed in enclosure (1), it is unclear as to whether the vessel was subject to the damage stability criteria in 46 CFR 28.580 and we noted that the T&S booklet did not evaluate any damage conditions. However, our independent review found that, based on the lack of watertight subdivision on the processing deck, the ALASKA RANGER would likely not have met the damage stability requirements in any condition of loading.

2. As requested in paragraph 5-b of ref (a), we performed two stepwise analyses of the sinking scenario. Based on the complete loss of one rudder and rudder post, it was estimated that the rudder room would have completely flooded in approximately 5 minutes. Progressive flooding into the surrounding spaces was modeled including the effects of free surface. Once the engine room had completely flooded, the trawl deck would have been awash greatly increasing the risk of catastrophic downflooding. Our analysis also suggested that flooding on the processing deck was a potential cause of the hard starboard list described in ref (a). Ultimately, a lack of effective watertight subdivision probably allowed the progressive flooding which sank the ALASKA RANGER.

3. Enclosure (1) is a detailed explanation of our assumptions and analysis.

4. If you have questions or need additional information on the details of the analysis performed, please contact LT [REDACTED] of our staff.

#

Encl: (1) Explanation of Analysis & Assumptions

EXPLANATION OF ANALYSIS & ASSUMPTIONS

1 General Comments Regarding the Stability Analysis

- All longitudinal references in this report are measured from the forward perpendicular, at frame 0. Vertical references and drafts are measured from the baseline.
- All weights are reported in long tons (LT).
- In their calculations, Elliott Bay Design Group (EBDG) considered only the engine room air intakes located on the inboard side of the gantry house at frame 50, 4 feet 3 inches above the trawl deck as downflooding points. While there are certainly other downflooding points like the ventilation openings for the harbor generator room, in the absence of any other information, EBDG's downflooding points have been used throughout this analysis.
- In the absence of more complete information about the vessel, the heeling moments used in EBDG's calculations for lifting and towing criteria were considered correct and used for the regulatory portion of this analysis.
- Creative Systems General HydroStatics (GHS) software version 11 was used for the analysis.
- The GHS geometry model provided as an enclosure to reference (a) was modified using the drawings provided to create compartmentation for damage stability and casualty simulation analyses.
- The Hydraulics Room, Machinery Space, and Harbor Generator Room were assigned permeabilities of 85%. All other spaces were assumed to be 95% permeable.
- The progressive flooding scenario portion of this analysis does not include the effects of wind or waves and thus should be considered purely static.

2 Regulatory Stability Review

2.1 *Stability Test Review*

The stability test information provided in EBDG's report 05015-1-1510, Rev. –, dated September 29, 2005 was reviewed as requested in reference (a). Using the data recorded during the stability test, our independent calculations confirmed the numerical results calculated by EBDG. The report itself calls out a number of discrepancies from what would be considered standard practice on a commercial vessel in certificated service. As such, if the stability test results had been submitted to the Marine Safety Center, they would likely have been returned for revision.

In particular, EBDG notes that the vessel was not complete or prepared for inclining as required in ASTM F 1321. We concur that the quantity of fishing gear and other deadweight items aboard the vessel was inappropriate, unnecessarily degrading the accuracy of the test. EBDG

accommodated this by using an “operational lightship” which includes spares, some stores and some crew effects. Without detailing these deadweight items, it is very difficult to establish accurate loading conditions.

In addition, we noted the following additional discrepancies with the conduct of the test:

- EBDG used three manometers to calculate heel angle, the Marine Safety Center’s interpretation of the ASTM F 1321 requires the use of at least one pendulum in conjunction with manometers.
- Although EBDG did take the free surface effects of these tanks into account when calculating the lightship vertical center of gravity (VCG), during the ALASKA RANGER’s stability test there were seven slack tanks. ASTM F 1321 recommends having no more than one pair of slack tanks, during an inclining experiment.
- When examining the inventory of the 58.89 long tons of fishing gear aboard during the inclining, it is clear that the longitudinal and vertical centers of much of that equipment were roughly estimated. The lack of apparent precision in the location of the fishing gear casts further doubt on the accuracy of the calculated lightship values.
- EBDG notes that the freeboard readings were not accurate to 1/8 inch as required by the ASTM and there is no indication in the report of the accuracy achieved during the test. For reference, with a TPI of 15.6 long tons per inch, every 1/8 inch of error in mean freeboard equates to approximately 1.95 long tons of error in displacement.

Despite the discrepancies noted above, the lightship data calculated by EBDG and used throughout their stability calculations provided the best information available regarding the ALASKA RANGER’s lightship characteristics. As such, the values determined by EBDG and verified in our review were used throughout the remainder of this analysis.

2.2 Intact Stability Review

The ALASKA RANGER’s Trim and Stability (T&S) booklet, Rev. A, was prepared by EBDG, and uses a conventional approach to providing loading guidance. In general, the requirements of 46CFR 28.530 are met when both the T&S booklet and the Stability Supporting Data booklet are considered together.

The loading guidance provided to the vessel’s master is based upon the use of maximum VCG curves. A maximum VCG curve, like those shown in Figure 1, shows maximum allowable VCG for the entire vessel over a range of displacements. Because the shape of maximum VCG curves is dependent on trim, separate curves are generated for different longitudinal centers of gravity (LCG). In EBDG’s analysis, separate curves were generated for four of the applicable criteria:

- 46 CFR 28.575 - Severe Wind and Roll
- 46 CFR 28.570 - Intact Righting Energy
- 46 CFR 173.020 - Intact Stability When Using Lifting Gear
- 46 CFR 173.095 - Dynamic Towline Pull

A composite set of curves was generated by finding the most restrictive criteria for each displacement/LCG combination. In order to use these curves, shipboard personnel were required to calculate their displacement, LCG, and VCG including a correction for the destabilizing effects of partially full tanks, known as free surface effects. The displacement and VCG were plotted as a point and compared to the appropriate LCG curve.

In order to verify the loading guidance provided in the T&S book, an independent generation of the ALASKA RANGER's max VCG curves was undertaken. In our review, the maximum VCG was computed using the four criteria considered by EBDG as well as the water on deck criteria in 46 CFR 28.565. As seen in Figure 1, there was good correlation between EBDG's and MSC's intact stability analyses. Our review revealed that the water on deck criteria was not limiting in any case so EBDG's omission of this criteria from their maximum VCG curves did not impact the results.

In general, the limiting criteria were the Intact Righting Energy requirements contained in 46 CFR 28.570. Specifically, the GM requirement and righting energy between 30° and downflooding were the most restrictive. Since the lowest downflooding points were aft on the ALASKA RANGER, aft trim conditions at deeper drafts quickly reduced the allowable VCG as seen in Figure 1 on the LCG = 105 curve at displacements greater than 2900 LT.

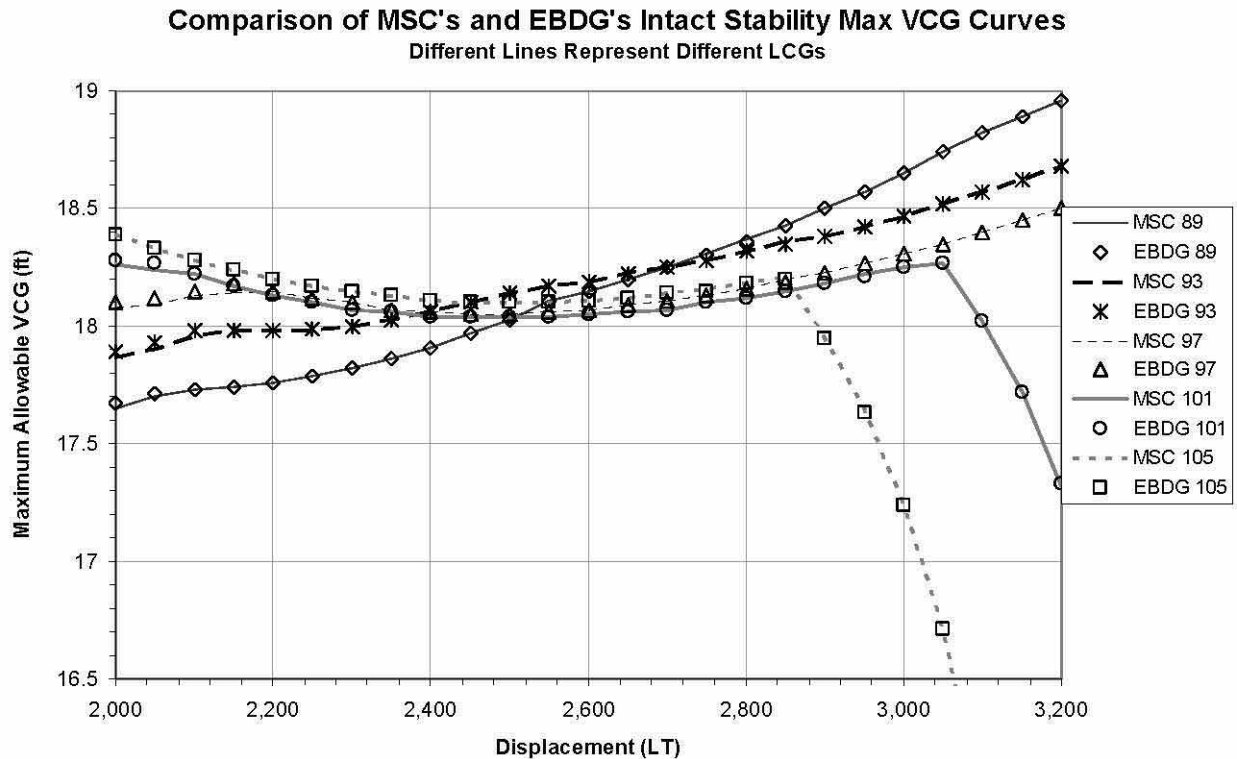

Figure 1: Comparison of Max VCG Curves

The load cases provided in the T&S booklet, including topside ice as required by 46 CFR 28.550, are plotted in Figure 2. It should be noted that the stability calculations in the ALASKA

RANGER's T&S booklet included an illustrative load case #5 which failed to meet the criteria, as well as a modified version, load case #5A which passed.

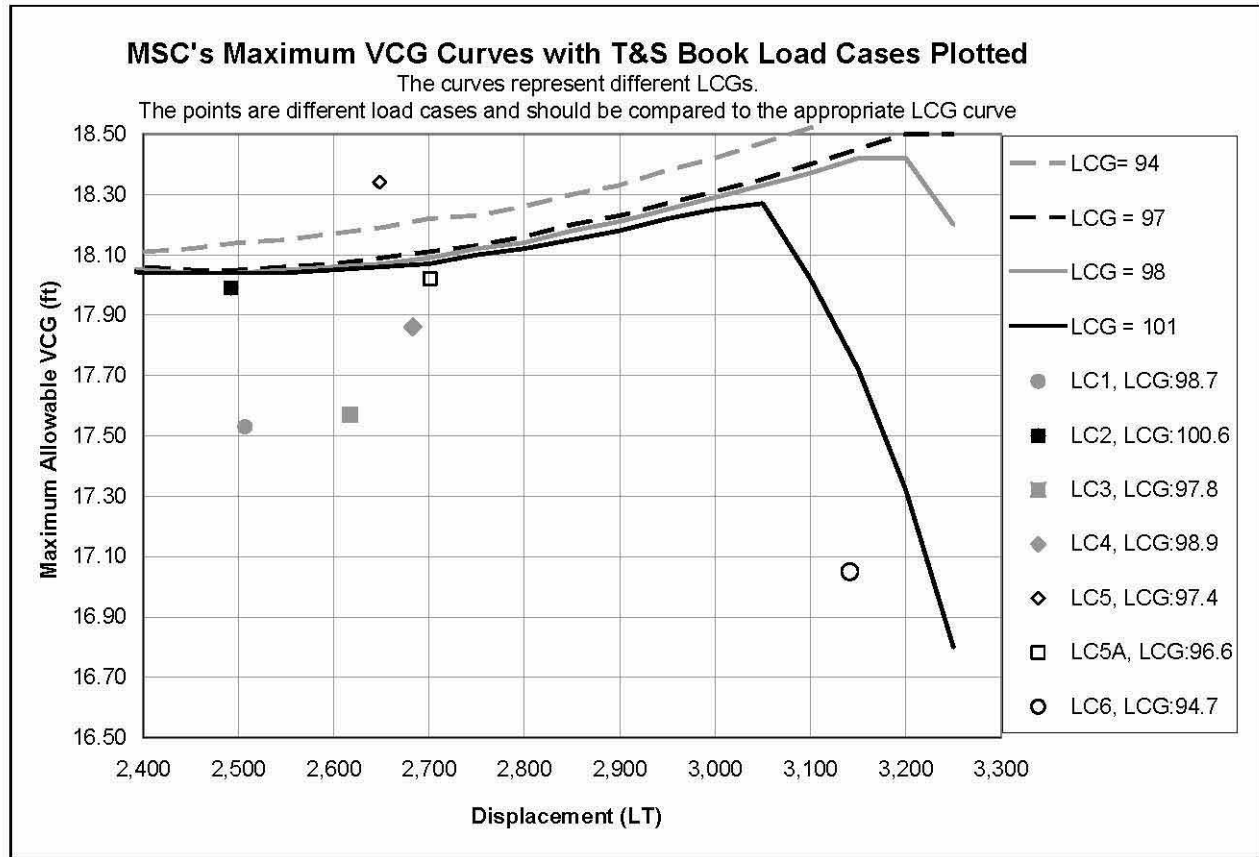

Figure 2: Load Case Evaluation

There was not sufficient information available to evaluate the ALASKA RANGER's compliance with the freeing port requirements in 46 CFR 28.555 as requested in reference (a).

2.3 Damage Stability:

The damage stability requirements for commercial fishing vessels over 79 feet in length and built after September 15, 1991 are located in 46 CFR 28.580. Since the ALASKA RANGER converted to a fishing vessel in 1989, the applicability of the damage stability requirements hinges on whether or not the vessel underwent a major conversion after September 15, 1991. Unfortunately, reference (a) doesn't contain sufficient information regarding a major conversion determination for this vessel.

Based on the information provided with reference (a), it appeared that EBDG did not evaluate damage stability. However, using the load cases provided in the T&S Book, we performed an independent analysis to see if our model would have met the damage stability requirements of 46 CFR 28.580 using the same loading conditions as the intact analysis. The results of the damage stability analysis are summarized in Table 1. Our model failed every loading condition. It was assumed that the watertight bulkheads and doors shown in the vessel's drawings were effective for all cases.

Damage Case	Compartments Damaged	T&S Book Loading						Pre-Casualty
		1	2	3	4	5A	6	
1	Forepeak Ballast, Focsle Deck	P	P	P	P	P	P	P
2	#1 & #2 FO Tanks, Hold#3, Focsle Deck	P	P	P	P	P	P	P
3	#3 FO Tank, Processing Deck	F	F	F	F	F	F	F
4	Engine Room Wing Tanks, Processing Deck	F	F	F	F	F	F	F
5	#4 FO Tank, Engine Room, Starboard Stair Tower, Workshop Space	F	F	F	F	F	F	P
6	#4 FO Tank, Aft Workshop Space	P	P	P	P	P	P	P
7	Aft Ballast Tank, Aft Stores	P	P	P	P	P	P	P
8	Engine Room	P	P	P	P	P	P	P
9	Rudder Room	P	P	P	P	P	P	P

Table 1: Summary of Damage Stability Result

The failure to meet the requirements in 46 CFR 28.580 was due to the configuration of watertight compartments rather than loading conditions. The damage stability requirements of 46 CFR 28.580 assume a 30 inch transverse extent of damage which extends vertically without limit. Typically, vessels subject to this damage requirement are constructed with a strip of tanks down each side in order to mitigate the effect of flood water. The ALASKA RANGER only had such tanks from the keel to the processing deck. However, the processing deck and hydraulics room lack this 30 inch wide belt of tanks. As a result, flooding the processing deck or engine room created a large floodable volume and a very large free surface that prevented the model from passing the damage stability criteria. It should also be noted that for damage cases 3 and 4, where the processing deck was damaged, the model not only failed all the regulatory requirements, but the large free surface also caused capsizes.

It is interesting to note that reference (a) indicated that the flooding aboard the ALASKA RANGER began in the rudder room, which is the same as damage case 9 in Table 1. Based on the results of our review, flooding in the rudder room alone should not have resulted in capsizing or sinking.

2.4 Limiting Displacement and Trim

Paragraph 2-e of reference (a) requested a determination of the maximum trim angles and displacements for which the ALASKA RANGER could pass the applicable intact and damaged stability requirements. Since the vessel did not meet the damage stability requirements of 46 CFR 28.580 in any of her conditions of loading, damage stability was excluded from this portion of the analysis. Based on the information provided, at the time of the casualty the ALASKA RANGER had a large intact stability margin for VCG, trim, and displacement. This large margin created many combinations of displacement and trim at which the vessel would meet intact stability requirements. Figure 3 displays the limiting KG curves over the range of displacements considered in the T&S booklet load cases. The dotted curve shows the forward most LCG considered among the load cases and corresponds to 2.9 feet of forward trim. The solid curve represents the aft most LCG corresponding to 3.5 feet of trim by the stern.

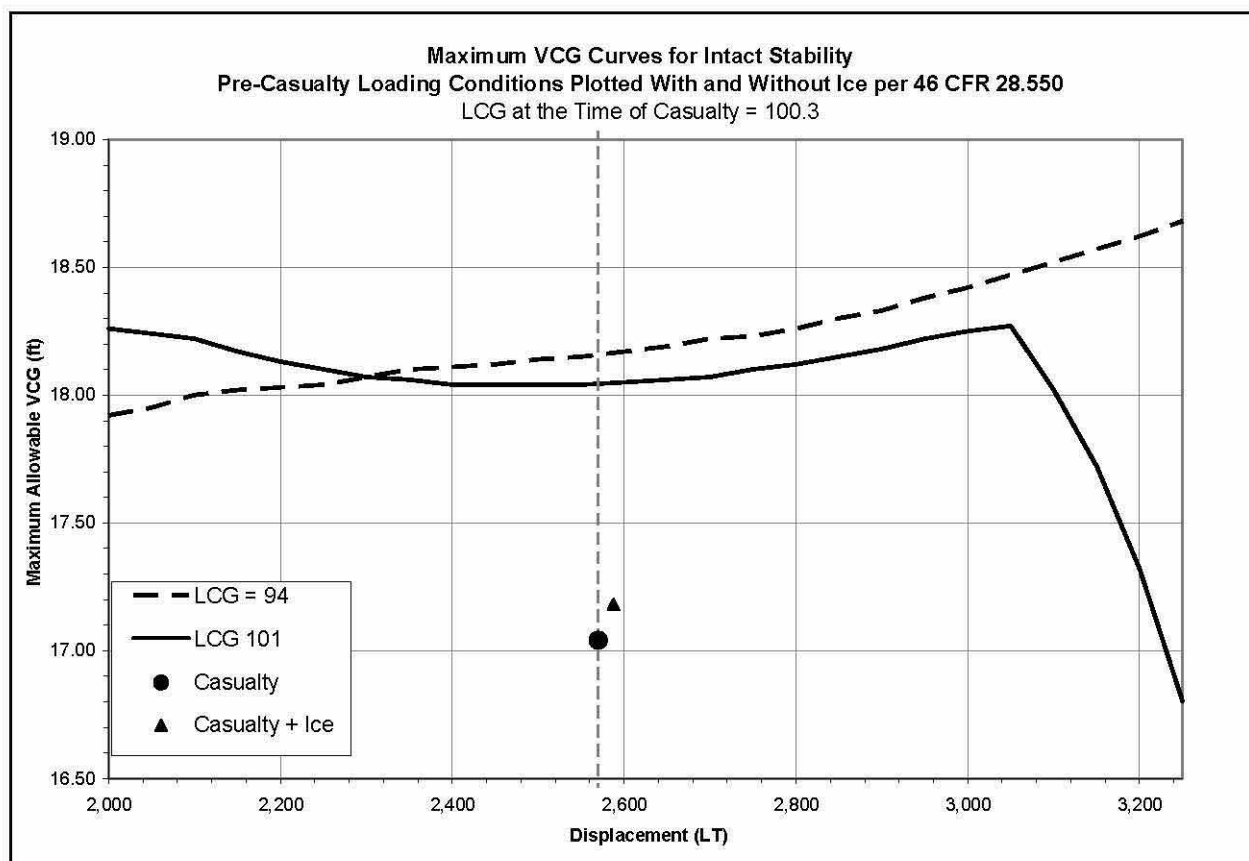

Figure 3: Range of Stability

3 Major Conversion Determination

The Marine Safety Center makes major conversion determinations on a case by case basis, based upon the criteria in Title 46 USC §2101(14a). The first part of the request in paragraph 4 of reference (a) was to determine whether or not conversion from a fishing vessel to a fish processing vessel would be a major conversion. Since both fishing vessel and fish processing vessel are types well defined in the USC §2101, moving from the strict definition of one vessel type to the other would likely be judged a major conversion. However, the request in reference (a) to determine whether the change from a fishing vessel engaged in some processing activities to a fishing vessel engaged in more extensive processing activities constitutes a change in the type of the vessel is not possible without examining the details of such a change.

4 Sinking Scenarios:

4.1 Initial Condition

Based upon the information in the T&S booklet for full load departure as well as the additional modifications called out in paragraph 5-c of reference (a), an estimate of the pre-casualty loading condition was developed. This estimate is summarized in Figure 4. The 122,000 gallons of fuel

takes into account 12,000 gallons in the day tanks as well as 110,000 gallons in the fuel oil storage tanks.

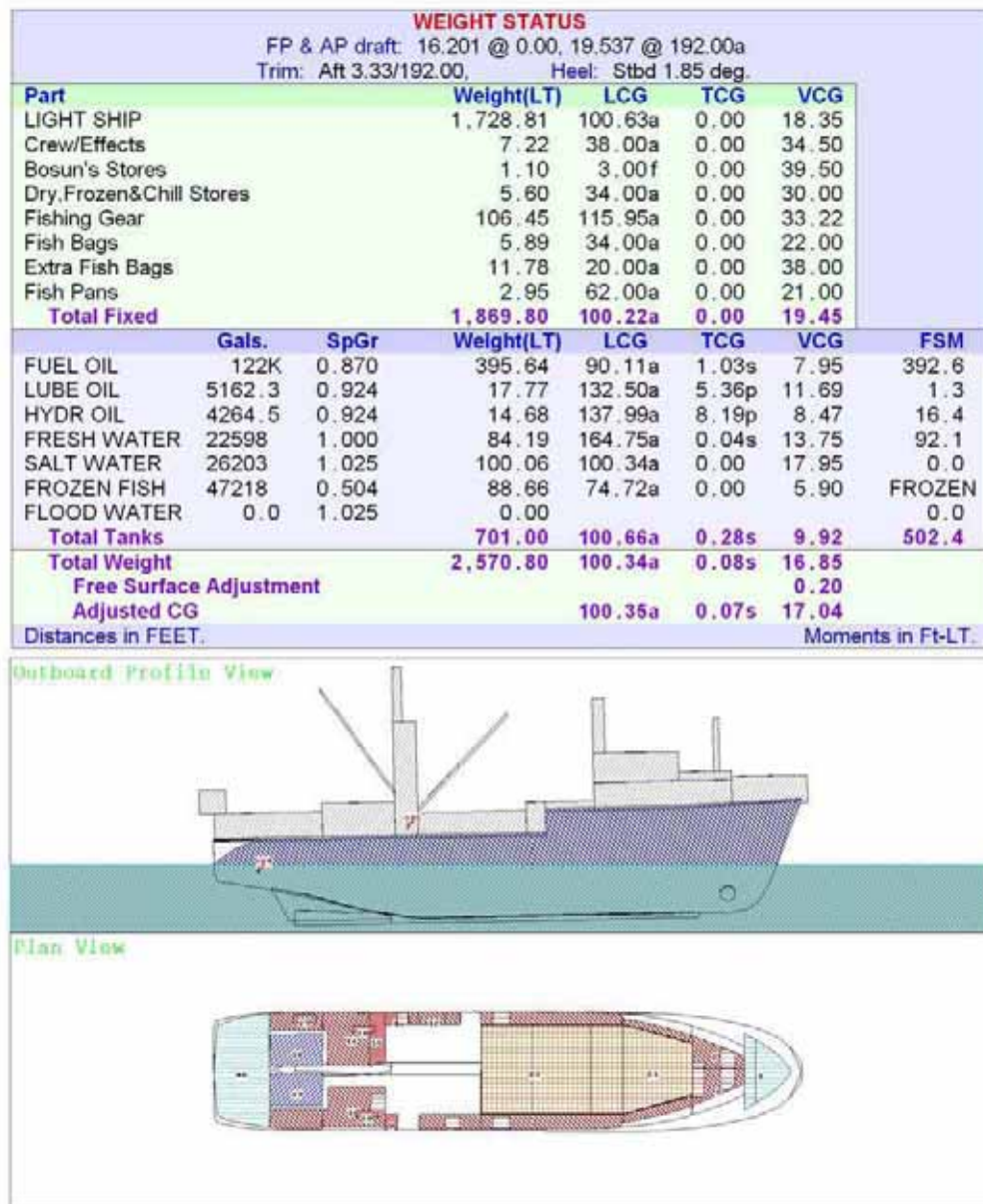

Figure 4: Summary of Pre-Casualty Load Condition

Figure 5 is taken from the ALASKA RANGER's arrangement plans for the hold and main decks. All of the compartments discussed in the sinking scenarios are labeled. In addition, there are dotted lines showing the locations of the body plan cuts used in figures 7 through 15.

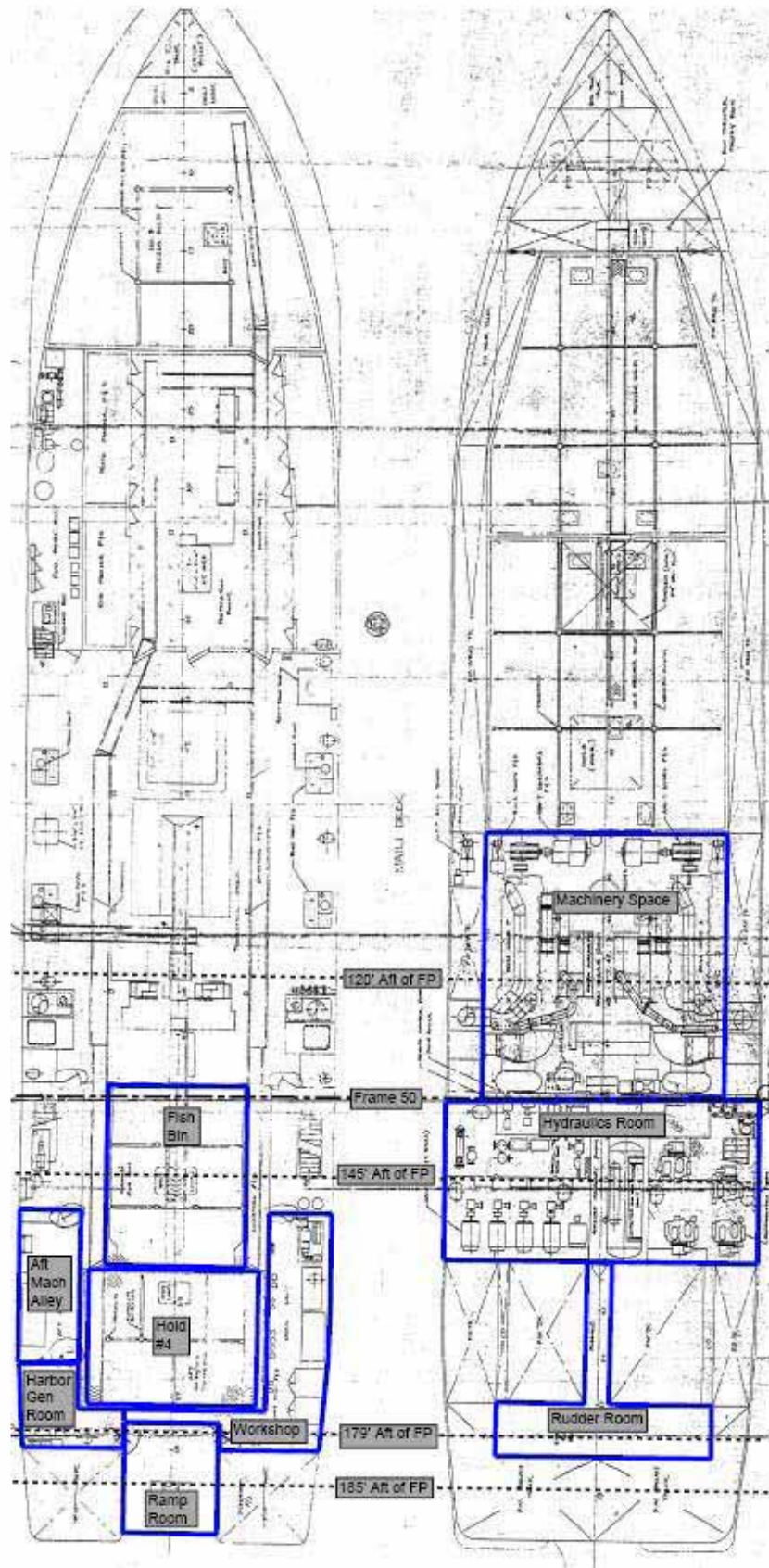

Figure 5: Plan View for the Main and Hold Decks Showing Relevant Compartments

4.2 Flooding Rate Assessment

The initial rate of flooding into the Rudder Room was estimated by assuming that the flooding began through the rudder bearing, after the complete loss of one rudder and shaft. McDermott Shipyard Dwg. No. 54271-2101-1, Rev 2, dated October 25, 1973 shows that the upper rudder tube bearing is 9 inches in diameter. It also indicates that the longitudinal, transverse and vertical locations of the top of the rudder tube as being 178.59ft aft of frame 0, 10.75 ft outboard from centerline and 16.85 ft above baseline. Figure 6, shows the ALASKA RANGER's body plan at the location of the rudder posts. The points labeled "cp3" and "cp4" are the locations of the top of the rudder bearing and the assumed location of flooding.

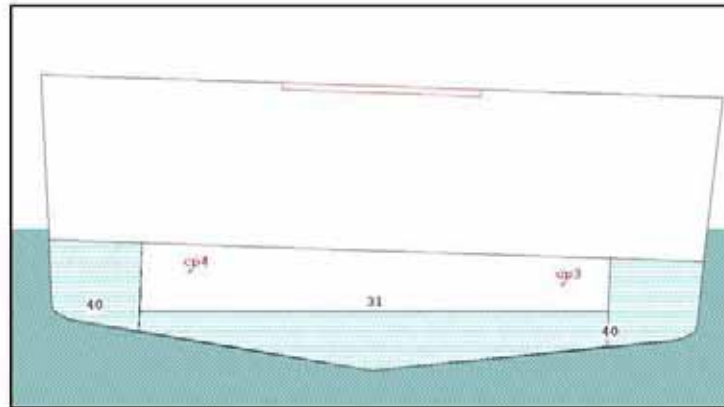

Figure 6: Example of Rudder Room Flooding at 50%

One simple method to estimate flow rate through a hole below the water line is:

$Q = 3600 A \sqrt{H}$, where:

Q = Flow rate in gallons per minute

A = Area of the hole in ft^2

H = Depth of the hole below the waterline in ft

% Flooded	Floodwater (LT)	Trim (ft)	H (ft)	Flood Rate		Time to Flood (Min)
				(gpm)	(LT/Min)	
0%	0.0	3.33	2.73	2657	10.12	0.0
25%	13.6	3.68	3.02	2762	10.52	1.3
50%	27.2	4.06	3.23	2859	10.89	2.6
75%	40.8	4.44	3.45	2951	11.24	3.8
100%	54.4	4.82	3.62	3027	11.53	4.8

Table 2: Rudder Room Flooding Analysis

As seen in Table 2, based on the assumptions above, the Rudder Room would have flooded very quickly with the complete loss of one of the rudders. Although the model trimmed aft as the rudder room flooded, the rate of flooding didn't change appreciably. Even if the initial flood rate of 2657gpm were assumed constant, the time to flood the Rudder Room solid only increases by 33 seconds.

Unfortunately, the rates of progressive flooding into the adjacent compartments can not be estimated in the same manner. In order to predict such rates, the shapes, sizes and locations of

each penetration from one compartment to another would need to be known. However, as will be discussed later, if the only source of flooding is assumed to be through the rudder bearing, then a rough estimate of the total time to take on a particular quantity of flood water may be made.

4.3 1st Progressive Flooding Scenario

Figure 7 labels the compartments on the body plan cuts used throughout the remainder of the analysis. The longitudinal location of each cut may be seen in Figure 5

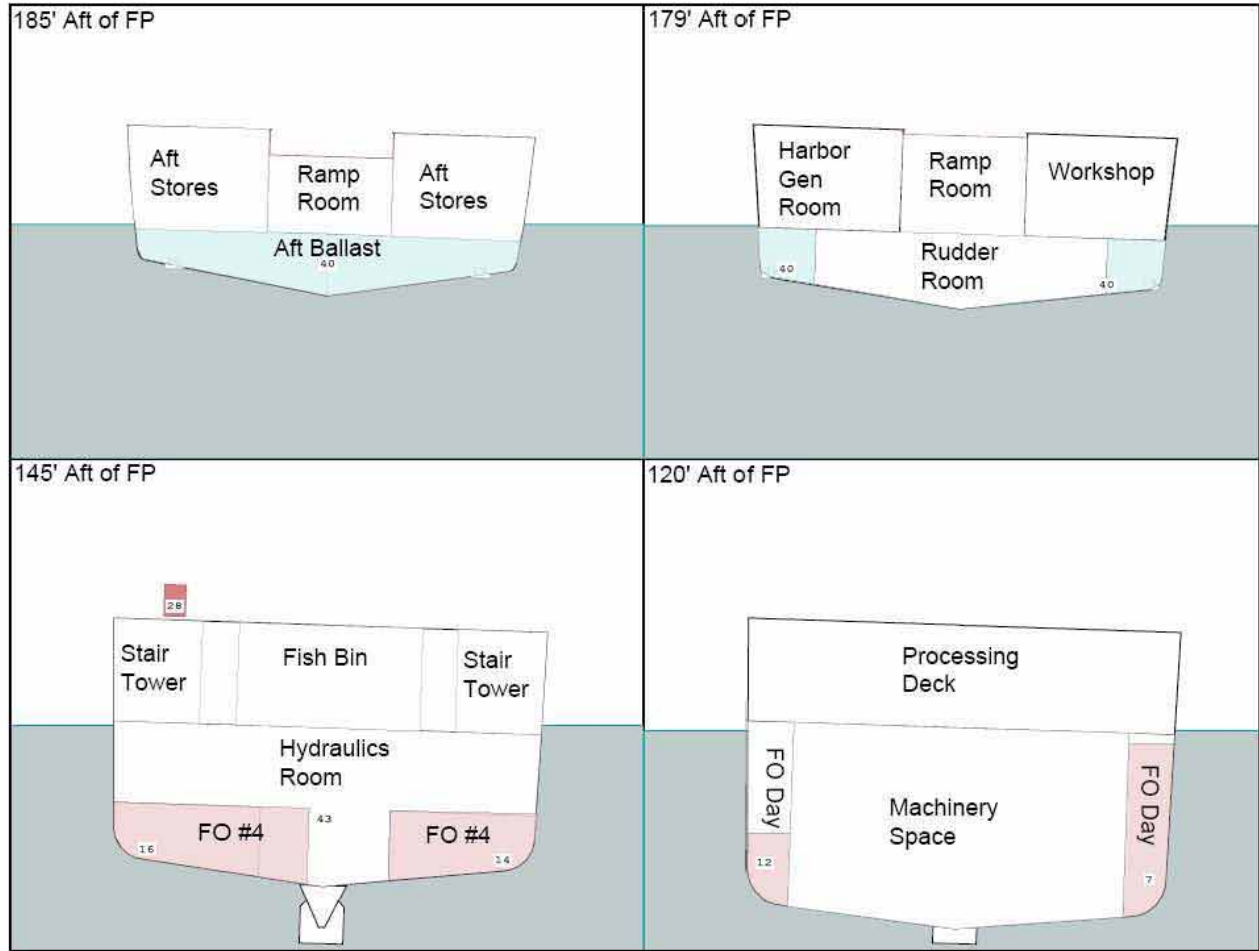

Figure 7: Body Plan Space Descriptions

Step	Compartments Freely Flooded	Heel Angle	Min Freeboard	Height of DF Point	Total Flooding
		(°)	(ft)	(ft)	(LT)
A	None	1.9	7.90	12.08	0
B	Rudder Rm	1.8	6.97	11.66	54
C	B+ Ramp, Harbor Gen Rm, Workshop, & Aft Mach Alley	4.2	5.48	10.61	97
D	C+ Engine Room	1.2	-3.07	5.74	904
E	D+ Fish Bin and Hold #4	29.0	-50.56	-9.10	1116

Table 3: 1st Progressive Flooding Scenario Synopsis

Reference (a) indicated that after the Rudder Room flooded, the next compartments to have reported flooding were the Ramp Room as well as the Harbor Generator Room, Workshop, and Aft Machinery Alley. The flooding of these compartments was modeled as step C in Table 3, and is depicted in Figure 8. In our model, these flooded compartments were allowed to flood to the waterline throughout the scenario so that as the flooding progressed, more water would flow in. It is not clear whether this floodwater came from a hull breach or upward from the rudder room below. However, our model suggested that with the rudder room flooded, the deck in the ramp room would have been 2 feet below the static water line, making a hull breach a reasonable source of flooding.

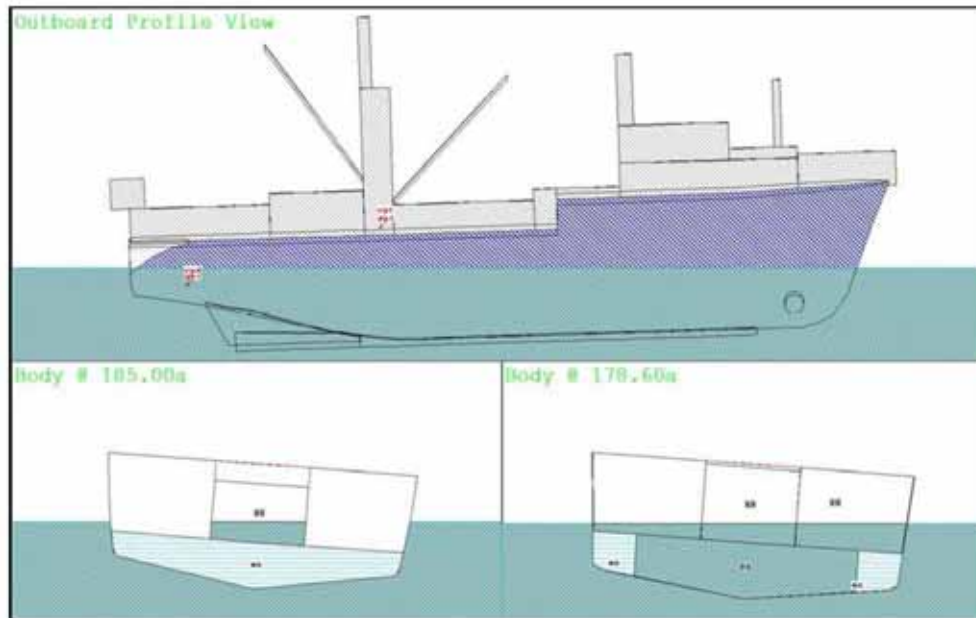

Figure 8: Step C in 1st Flooding Scenario

Reference (a) indicated that the Hydraulics Room was the next compartment to flood. The bulkhead at frame 50 was not watertight and so in step D, the entire engine room was allowed to flood. As seen in Figure 9, once the engine rooms were completely flooded, the aft portion of the trawl deck is awash increasing the likelihood that the #4 Hold and the Fish Bin would begin to downflood.

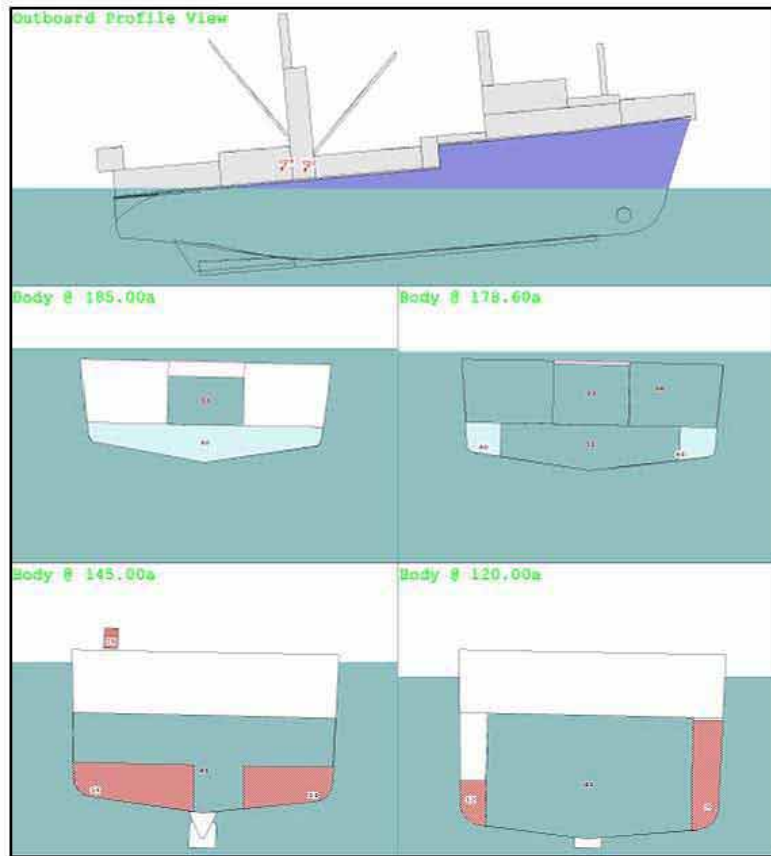

Figure 9: Step D in 1st Flooding Scenario

Figure 10 shows the model's attitude with the Fish Bin and #4 Hold flooded. Although this analysis describes one potential sinking scenario, it doesn't predict any significant listing until the model had extreme trim by the stern. Please note that this sinking scenario neglects the effects of wind and sea conditions.

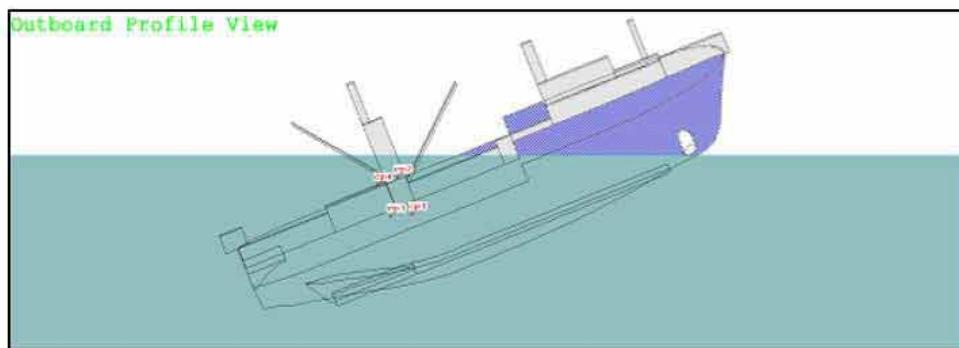

Figure 10: Step E in the 1st Flooding Scenario

4.4 2nd Progressive Flooding Scenario

Step	Compartments Flooded	Heel Angle	Min Freeboard	Height of DF Point	Total Flooding
		(°)	(ft)	(ft)	(LT)
A	None	1.9	7.90	12.08	0
B	Rudder Rm	1.8	6.97	11.66	54
C	B+ Ramp, Harbor Gen Rm, Workshop & Aft Mach Alley	4.2	5.48	10.61	97
D	C+ 4.8ft of SW@ Fr50 in Hydraulics Rm	4.0	5.27	10.52	117
E	C+ 6.8ft of SW@ Fr50 in Hydraulics Rm	4.0	5.04	10.42	135
F	E + 4.8ft of SW@ Fr50 in Fwd Mach Rm	4.8	3.33	9.19	291
G	E+ 6.8ft of SW@ Fr50 in Fwd Mach Rm	3.7	3.10	9.13	351
H	C+ 8ft of SW@ Fr50 in Engine Rm	4.3	2.36	8.63	405
I	C+ 10ft of SW@ Fr50 in Engine Rm	5.2	0.91	7.66	511
J	I+ 15LT of SW on Processing Dk	7.8	-0.02	6.82	521
K	I+ 50LT of SW on Processing Dk	16.3	-3.27	3.94	561
L	I+ 100LT of SW on Processing Dk	36.0	-13.07	-4.1	614

Table 4: 2nd Progressive Flooding Scenario Synopsis

Reference (a) indicated that the vessel listed hard to starboard after losing power. There was little indication of asymmetric flooding and so the list would likely have been due to the large free surface effects associated with partially flooded compartments. Because the top of the model's engine room was below the static waterline, the compartment would flood solid rapidly and not allow for any free surface as depicted in Figure 9. In contrast to the free flooding considered in the previous scenario, the 2nd scenario assumed the model was loaded with sea water up to a particular height at frame 50 in order to include the effects of free surface.

The engine room aboard the ALASKA RANGER was assumed to be made up of two separate compartments until flood water reached the main engine shafts. Cutouts in the bulkhead at frame 50 were considered to be the point where flood water would begin spilling from the hydraulics space forward into the machinery space. This spilling would have begun when there was approximately 6.8 ft of water at the forward end of the hydraulics room. This corresponds to approximately 29.5 LT of seawater as shown in Figure 11. After the spilling occurred, the forward machinery portion of the engine room was filled until the level at the spill point matched that in the hydraulics space. This occurred on the model with approximately 182 LT of water in the forward machinery space as shown in Figure 12.

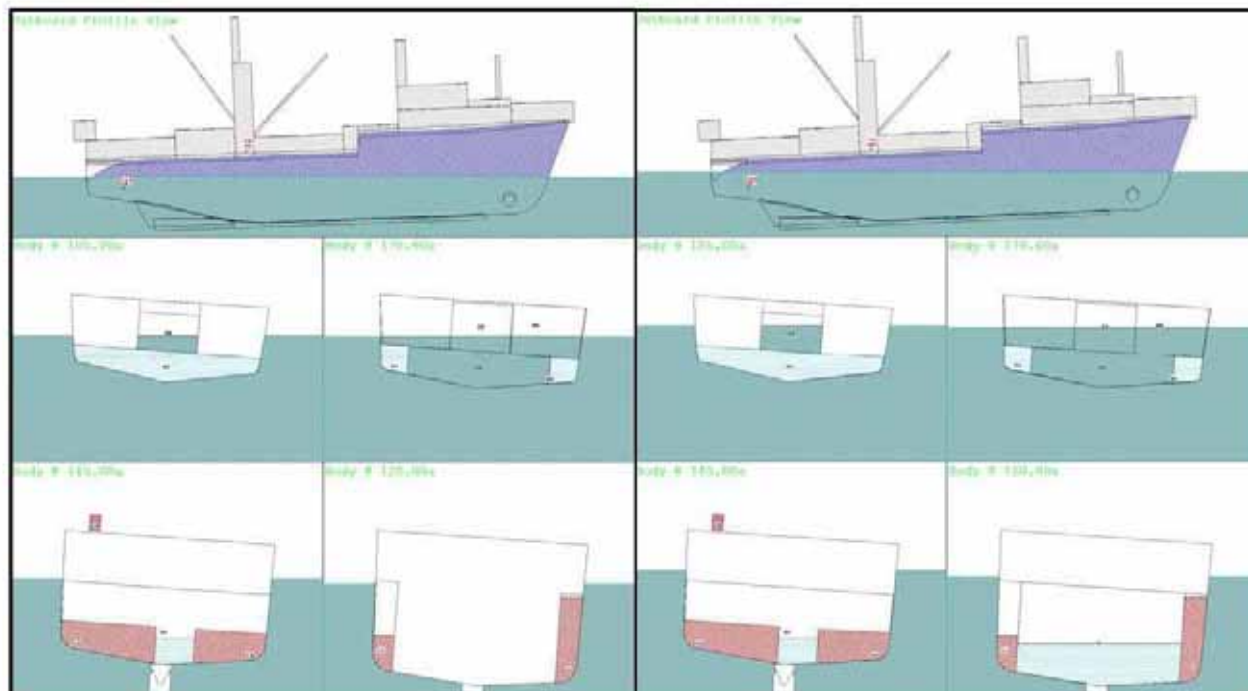

Figure 11: Step E in the 2nd Flooding Scenario

Figure 12: Step G in the 2nd Flooding Scenario

Reference (a) also indicated that by 03:45, or 1 hour and 45 minutes after the initial report of flooding in the rudder room, the ALASKA RANGER had lost her generators and main diesel engines. It was assumed that the loss of the main engines corresponded to step I in the scenario where the engine rooms were flooded with 10 ft of water. Using the slowest flood rate in Table 2, the total 511 LT of flood water in all flooded compartments, would have taken approximately 50 minutes to ship through the rudder bearing. Presumably, the progressive flooding between compartments would occur more slowly than the initial flooding into the rudder room. However, this rough check verified that the flooding rates discussed in section 4.2 were not out of the question when compared with the timeline in reference (a).

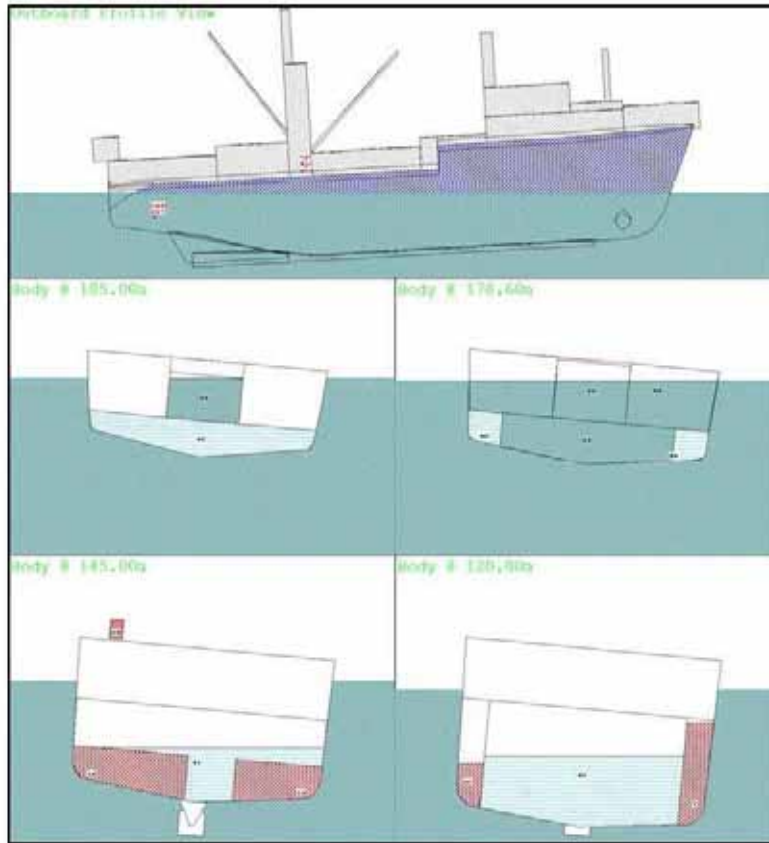

Figure 13: Step I in 2nd Progressive Flooding Scenario

As noted previously, the ALASKA RANGER reportedly listed hard to starboard after losing power (presumably due to flooding in the engine rooms). However, Table 4 shows only between 4° and 5° static starboard heel angle once the engine rooms are flooded. One plausible condition that would increase the free surface effect and create a greater heel angle is a small quantity of flood water on the processing deck. Limited flooding on the processing deck is a reasonable assumption considering the aft end of the trawl deck was nearly submerged in step I of the scenario. When only 15 LT of flood water was added to the processing deck, the model heeled sufficiently to put the starboard corner of the transom in the water as shown in Figure 14. With 50 LT of flood water on the processing deck, the heel angle doubled to 16°. At this point, our model indicated that the starboard side of the trawl deck was underwater from frame 47 to the transom.

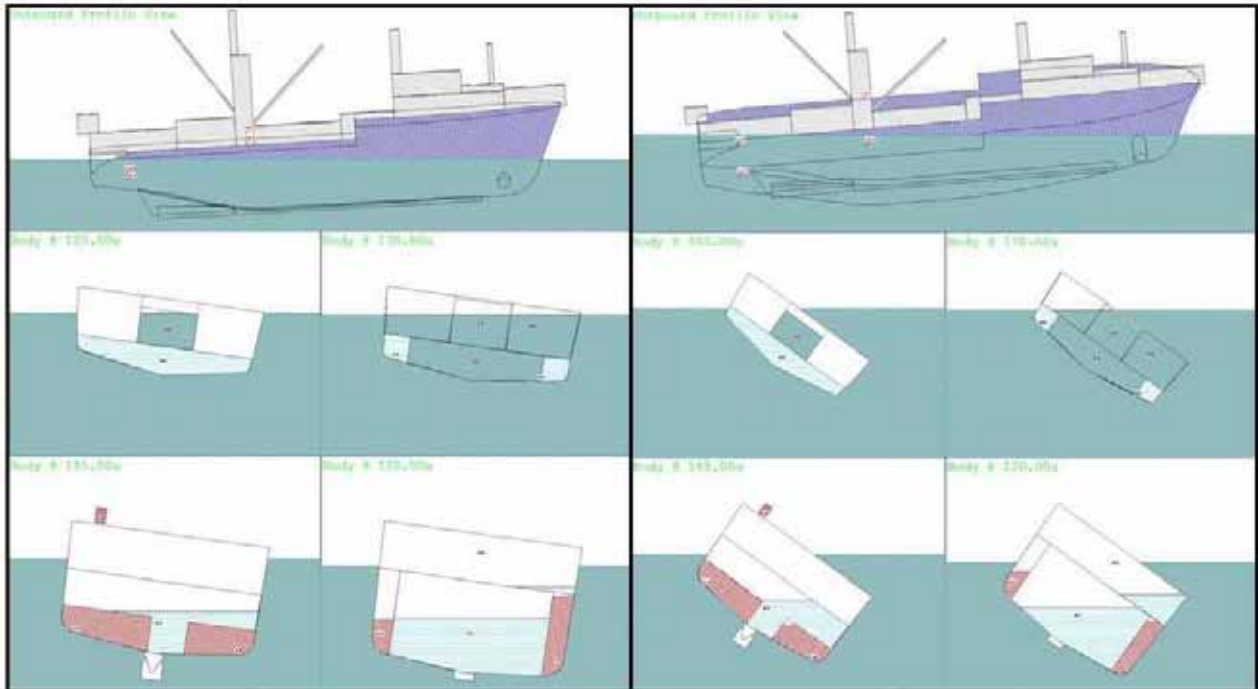

Figure 14: Step J in 2nd Flooding Scenario

Figure 15: Step L in 2nd Flooding Scenario

Figure 15 depicts step L in the flooding scenario. Here, the processing deck was flooded with 100 LT of sea water. At this point, the model was heeling 36° to starboard with the trawl deck awash and the engine room downflooding points submerged. Further speculation on the next compartments to flood and their effect on stability provided little value and was fraught with inaccuracy. Additionally, only the lowest downflooding points were considered, whereas there were presumably other air vents on the superstructure that would have allowed the ingress of water. Ultimately, the order of further flooding does not change the outcome; once the engine room was flooded, water was flooding the processing deck, and the trawl deck was awash, our model indicated that the ALASKA RANGER could not have survived. Again, please note that this sinking scenario neglects the effects of wind and sea conditions.

Appendix E: Safety Alert 01-08 Regarding Watertight Integrity



UNITED STATES COAST GUARD
U.S. Department of Homeland Security

MARINE SAFETY ALERT

Assistant Commandant for Marine Safety, Security and Stewardship

May 9, 2008
Washington, DC

Alert 1-08

Maintaining Vessel Watertight Integrity

This Safety Alert addresses two issues: watertight integrity and high level bilge alarms. Recently a marine casualty involving a fishing vessel in the Bering Sea resulted in multiple fatalities and complete loss of the vessel. A Marine Board of Investigation is currently examining the various circumstances surrounding the casualty. Although the investigation is not complete, testimony indicates the flooding of the vessel may have been exacerbated due to open or leaking watertight doors and other compartmental deficiencies which impacted the vessel's overall watertight integrity.

As a result of this and other similar casualties, the U. S. Coast Guard **strongly recommends vessel owners and operators:**

WATERTIGHT INTEGRITY

Ensure all watertight decks and bulkheads are inspected periodically to verify that there are no unprotected openings or improper penetrations that will allow progressive flooding and that closure devices (e.g. watertight doors, duct closures, etc.) are in place and in working order.

Ensure all crewmembers are familiar with the locations of the watertight doors (WTDs) and weather tight closures throughout their vessels. Knowing the locations of such WTDs and weather tight closures should be part of the crewmember vessel familiarization process.

Ensure WTDs and hatches are closed while at sea and as otherwise specified in the stability guidance provided to the master or individual in charge. The importance of keeping WTDs and hatches closed should be emphasized on a regular basis (e.g. at safety meetings). WTDs and hatches should be opened only briefly to allow passage and labeled appropriately to remind crewmembers to close them. If they must remain open to permit work, WTDs and hatches should be attended at all times so that they can immediately be closed. Any WTDs permitted to be open while the vessel is underway should be secured during drills to ensure they work properly.

Implement a WTD inspection program to ensure each WTD is regularly inspected and properly maintained. As part of the inspection of each WTD, the following should be examined: straightness of the knife edge; the door assembly for twisting or warp-age; evidence of loose, missing seized or damaged components; permanent set in gasket material, cracks in the gasket; gaps at gasket joints;

paint, rust, or other foreign material on gaskets, knife-edges and working parts; binding and difficult operations; and loose or excessively tight dogs. Rotating spindles of the dog, handles and hinges, and other points of friction should be lubricated to prevent seizing and allow proper closure. If fitted, the spindle packing should also be examined.

Ensure watertight hatches, dogged manholes, bolted manhole covers, and access plates are given similar examinations, focusing on the sealing surfaces and the method by which the hatch is secured. Gasket materials should be replaced whenever they are found insufficient. Regardless of the type of hatch or access, every component that secures the device, such as dogs, wing nuts, or bolts should be inspected, lubricated and free, and repaired or replaced as necessary to ensure they operate properly. As with watertight doors, hatches and accesses should be labeled to indicate they remain closed while underway. Most importantly, all securing devices must be used when the hatch or access is closed. Improper closure of a hatch will not prevent flooding.

Ensure compartments and external hull structures fitted with ventilation ducts that have hinged covers with gaskets, hinges, sealing surfaces and securing mechanisms are regularly inspected and properly maintained (see above for guidance).

Ensure electrical cables and conduits, piping runs, remote valve actuators, and other components that penetrate watertight bulkheads, decks, and compartments are inspected frequently and properly maintained. Each may have a unique sealing method involving glands with packing assemblies, penetration seals, or other methods. Frequent inspection and proper maintenance of these various fittings and assemblies will assist in minimizing the possibility of progressive flooding.

BILGE AND HIGH WATER ALARMS

Ensure water accumulation is minimized and all spaces are kept dry unless permitted by the stability instructions provided to the master or individual in charge.

Ensure bilge high level alarms are arranged to provide the earliest warnings of abnormal accumulation. The high level bilge alarms should be set as low as possible to the deck or bilge well and positioned along the centermost area of the compartment or in a location at which the fluids will gravitate to first. In areas where bilge water routinely accumulates, the bilge high level alarms should be placed just above the point where under normal working conditions the accumulation would be pumped to a holding tank, overboard, or through an oily water separation system if required. Alarms may be fitted with short time delays to prevent nuisance alarms caused by the rolling and pitching of the vessel.

Ensure all crewmembers understand the importance of minimizing water in the bilges. Provide the funding, labor, spare parts, and vessel availability necessary to ensure leakages stemming from machinery, equipment and other components are kept to a minimum at all times in accordance with good marine practice.

This safety alert is provided for informational purposes only and does not relieve any domestic or international safety, operational or material requirement. Developed and distributed by the Office of Investigations and Analysis, United States Coast Guard Headquarters, Washington, DC.

Appendix F: Safety Alert 03-08 Regarding CPP Systems and Situational Awareness



UNITED STATES COAST GUARD

U.S. Department of Homeland Security

MARINE SAFETY ALERT

Assistant Commandant for Marine Safety, Security and Stewardship

July 2, 2008
Washington, DC

Alert 3-08

Controllable Pitch Propeller Systems and Situational Awareness

A marine casualty in March of 2008 involving a fishing vessel in the Bering Sea resulted in multiple fatalities and complete loss of the vessel. A Marine Board of Investigation is currently examining the various circumstances surrounding the casualty. Although the investigation is not complete, safety issues associated with casualty have been identified that merit immediate public dissemination.

Based on the survivors' testimony, the crew experienced difficulty with launching and entering the three liferafts because the vessel was making considerable sternway when the order to abandon ship was issued. Evidence indicates the main engines were still running and the vessel was backing with significant astern pitch. Consequently, two of the liferafts quickly traveled forward past the bow of the vessel when they were launched. Attempts to retrieve the liferafts using the painter lines were unsuccessful. As a result, the majority of the crew members were forced to jump into the 34°F water and attempt to swim to the liferafts. Ultimately, only 22 members of the vessel's crew made it into the liferafts. All of these crew members survived. Of the other 25 crew members who never made it into a liferaft, four died and one remains missing.

The Coast Guard **strongly recommends** that owners, operators, and masters of vessels with controllable pitch propellers understand the design and operation of the system. This includes the primary and emergency sources of power for both the control and main systems, the location and procedures for using alternate control stations, and the locations of the emergency shutdowns. While controllable pitch propeller systems are generally designed and constructed to fail in the "as is" position, in hydraulic CPP systems, the actual blade pitch may change. In this case the vessel was making considerable sternway. This was not a unique occurrence. The MS EXPLORER also experienced this problem before it sank in November of 2007. Vessel operators, masters and crew members must be prepared to respond accordingly.

In light of this incident, vessel owners, operators, masters and crew members should also be mindful of the following safety issues:

1. Vessel masters and officers must maintain situational awareness at all times and understand the effects of their actions and decisions on the safety of their crew, especially during emergency situations involving flooding. This includes understanding what impact the vessel's speed, heading, heel, and trim will have on the crew as it abandons ship.
2. The master or individual in charge must evaluate the particular circumstances of each emergency situation (weather, seas, experience of crew, condition of vessel, etc.) and adjust emergency procedures accordingly to provide for the safety of his crew, vessel, and the environment.
3. All crew members should understand that immersion suits will affect their dexterity, limit mobility, and may make it more difficult to launch survival craft, particularly when the survival craft are covered with snow or ice. Crew members responsible for launching the survival craft should practice and be able to do so with their immersion suits on. Lifesaving gear should be kept free of ice and snow whenever possible.
4. When abandoning ship, crewmembers should make every effort to enter directly into a liferaft or lifeboat before entering the water. If crewmembers must enter the water, they should stay together and attempt to enter a liferaft, climb onto floating debris, or use any other means available to get themselves out of the water as soon as possible.
5. Emergency Drills should not be limited to routine procedures such as donning immersion suits. Emergency drills should ensure all crew members, including bridge and engine room personnel, understand and practice what to do in various emergency situations under actual conditions.

Additional information regarding emergency procedures for Commercial Fishing Vessels can be found at: <http://www.fishsafe.info> .

This safety alert is provided for informational purpose only and does not relieve any domestic or international safety, operational or material requirement. Developed and distributed by the Office of Investigations and Analysis, United States Coast Guard Headquarters, Washington, DC.

Appendix G: Summary of Activities by the Marine Board of Investigation

The Marine Board of Investigation convened in Dutch Harbor, Anchorage, Seattle, and Boston. We took formal testimony from 43 people addressing vessel operations, vessel stability, industry practices, USCG enforcement of commercial fishing vessel safety requirements, and the USCG's response to the casualty. We also informally interviewed many other people while researching information relevant to our investigation. We visited a similar vessel owned by the same company; viewed the survival suits used by the crewmembers of the ALASKA RANGER, and visited the facility where the controllable pitch propellers were manufactured.

Partners:

NTSB Investigators. We conducted the investigation simultaneously with four investigators from the National Transportation Safety Board. We greatly benefited from their cooperation, expertise, and wealth of knowledge.

Marine Safety Detachment Dutch Harbor. Instrumental in the success of the investigation was the support and investigative assistance we received from the officers and crew of MSD Dutch Harbor. From the time the USCG was notified of the casualty on 23 March until 4 April 2008 when the MBI moved to Anchorage, the waking hours of the members of MSD Dutch Harbor were consumed by the demands of the investigation.

Marine Safety Center: From the outset, the Marine Safety Center provided vital technical support to the investigation. Their review and analysis of the ALASKA RANGER's stability characteristics, as well as the evaluation of potential flooding scenarios that led to its loss, contributed directly to the findings of this report. The tremendous effort expended in modeling, evaluating evidence and running countless calculations proved essential in assisting the Board in its deliberations.

Commandant's Office of Investigations and Analysis (CG-545): At the conclusion of the field hearings, we asked the Office of Investigations and Analysis (CG-545) to provide technical analysis and review of some of the evidence. The Senior Technical Specialist spent months going through the evidence, identifying significant elements, and providing us assistance with drafting the report. His contributions were invaluable to the MBI.

Continuity:

When the hearings convened, D17 assigned a Legal Officer to assist. As we moved from venue to venue, we asked to keep this officer rather than receiving new counsel at subsequent locations, and D17 approved our request. This decision was extremely important. Our Legal Officer quickly became familiar with the issues and concerns surrounding the casualty and was able to expeditiously resolve several questions that arose during the hearings and prevented costly delays. D17 also provided dedicated a Public Affairs Specialist and a Court Reporter, both of whom were present at most of the public hearings. Their assistance and expertise were invaluable to the MBI.

Support:

We had a great network of support staff that enabled us to complete our investigation. Personnel from units in Sector Anchorage and Sector Seattle organized the hearings and handled the detailed logistics necessary to hold public hearings on such short notice. Personnel from the First, Thirteenth and Seventeenth Coast Guard Districts also assisted.

We also employed the talents and skills of individuals from the USCG Marine Safety Center and Engineering Logistics Center. These personnel assisted in gathering and interpreting the data to reach sound conclusions and make reasonable recommendations. It is vital to engage the technical specialists almost immediately in an investigation of this magnitude. If we had not done so may not have asked the right questions or obtained the evidence needed.

Report Preparation:

Due to the demands of the primary duties of the members of the Marine Board, we quickly concluded we would not be able to write the body of the report on a part time basis. We used six one week offsite meetings that enabled the MBI to focus on the investigation, analyze evidence, discuss the issues, and identify additional aspects of the casualty that needed further investigation. After each offsite we each had a series of “homework” assignments that allowed us to prepare the early drafts of the report. Ultimately, each member of the MBI spent at least ten weeks away on temporary additional duty and hundreds of hours working on the report while at his normal duty station.

Appendix H – Convening Order

U.S. Department of
Homeland Security

United States
Coast Guard



Commandant
United States Coast Guard

2100 Second Street, S.W.
Washington, DC 20593-0001
Staff Symbol: CG-545
Phone: (202) 372-1029
Fax: (202) 372-1907

16732

MAR 25 2008

MEMORANDUM

From: [REDACTED]

Reply to CG-545
Attn of: Mr. [REDACTED]
2-1036

To: CAPT Michael Rand

Subj: MARINE BOARD OF INVESTIGATION CONCERNING THE SINKING OF THE F/V
ALASKA RANGER ON THE BERING SEA ON 23 MARCH 2008 WITH MULTIPLE
LOSS OF LIFE

1. Pursuant to the authority vested in me by 46 USC 6301 and the regulations thereunder, a Marine Board of Investigation consisting of yourself as Chairman, CDR John Nadeau, USCG, Member, and LCDR [REDACTED] USCG, Member, is hereby ordered to convene as soon as practicable to inquire into all aspects of subject casualty at such times and places as directed by you.

2. The Board will investigate thoroughly the matter hereby submitted to it in accordance with the provisions of 46 USC 6301, et. seq., and the regulations thereunder. Upon completion of its investigation, the Board will report to the Commandant the evidence adduced, the facts established thereby, and its conclusions and recommendations with respect thereto, except that any conclusions or recommendations concerning commendatory actions or misconduct which would warrant further inquiry shall be referred by separate correspondence to the cognizant district commander. A daily summary of significant events shall be transmitted to Commandant (CG-545) while the Board is in formal session.

3. Complete and submit your investigative report to Commandant (CG-545) within six months of the convening date. If this deadline cannot be met, a written explanation for the delay and the expected completion date shall be submitted. You are encouraged to submit interim recommendations intended to prevent similar casualties, if appropriate, early in your investigation.

4. The National Transportation Safety Board (NTSB) is also charged with the responsibility of determining the cause or probable cause of this casualty by the Independent Safety Board Act of 1974 (49 USC 1901, et. seq.) and may designate a representative to participate in this investigation. The NTSB representative may make recommendations regarding the scope of the inquiry, may identify and examine witnesses, and may submit or request additional evidence.

Subject: MARINE BOARD OF INVESTIGATION CONCERNING THE SINKING OF THE
F/V ALASKA RANGER ON THE BERING SEA ON 23 MARCH 2008 WITH
MULTIPLE LOSS OF LIFE

5. The Commandant (CG-545) will furnish such funding and technical assistance as may be required by the Board when deemed appropriate and within the requirements for the scope of this investigation. Commander Seventeenth Coast Guard District and Commander Thirteenth Coast Guard District will provide such administrative and legal support as may be required.

Copy: COPACAREAREA(p)
CCGD17(p)
CCGD 13(p)
Sector Anchorage
Sector Seattle